

Technical brochure  
July 2024



**DURAGROOVE™**  
WALL CLADDING SYSTEM



[www.innovafibrement.com.au](http://www.innovafibrement.com.au)



The stunning Innova<sup>TM</sup> range of facade, lining and flooring products will move you to reassess your concept of excellence in facades and flooring systems. Durable and dynamic, fresh and contemporary, Innova<sup>TM</sup> is already turning industry heads. Now let the Innova<sup>TM</sup> range of cladding and flooring products breathe new life into your creativity and project specification.

Contents

- 8 // Product Description including sizes and weight
- 8 // Product Information
- 8 // Fire resistance and Weather resistance
- 9 // Vapour Permeable Moisture Barrier
- 9 // Cutting and Drilling
- 10 // Accessories
- 11 // Fasteners
- 12 // Framing
- 12-13 // Stud Spacing
- 13-23 // Installation Details
- 24 // Thermal Breaks
- 25 // Bushfire and Boundary Wall Areas
- 26 // Painting and Maintenance
- 26 // Warranty

## **DURAGROOVE™** WALL CLADDING SYSTEM

For up-to-the-minute exteriors or interiors, choose Duragroove™ cladding. A peerlessly adaptable, vertically-grooved panel available in different profiles and spacing, Duragroove™ has a shiplap joint to ease and speed your installation.

Specify Duragroove™ for single-storey and medium-height projects. Duragroove™ comes in four variants:

- / Narrow (100mm)
- / Wide (150mm)
- / Extra Wide (400mm)
- / Wide Woodgrain (150mm)
- / Extra Wide Woodgrain (400mm)

### **Duragroove™ Wall Cladding System**

- / Vertical grooves – excitingly contemporary alternative to traditional weatherboard
- / Lightweight and durable
- / Factory sealed panels aid paint application
- / Quick to install – no need for taped and filled joints
- / Panels resistant to termites, air, steam, salt and sunlight

Specify Duragroove™ with confidence

[innovafibrement.com.au/fire-resistant](http://innovafibrement.com.au/fire-resistant)





## Innova™ deemed to comply external wall cladding systems.

- / Compressed Fibre Cement range
- / Architectural designed weatherboard range
- / Grooved and profiled cladding range

**Innova™ products have superior fire performance against four key indicies.**



**Ignition index = 0**

*Fibre cement does not ignite*



**Spread of flame index = 0**

*There is no spread of fire with fibre cement*



**Heat evolved index = 0**

*Heat does not evolve from fibre cement*



**Smoke developed index = 0-1**

*Smoke is not emitted from fibre cement*



Up to **BAL-40**  
as per AS3959



Stringently tested in Australia by **NATA** accredited authorities, validating high performance materials

# Case Study 01.

Project: New Home  
Location: Dunsborough, WA  
Builder: BR Building

The house is in a bush fire zone so non combustibility and meeting the Bushfire Attack Level ratings was paramount. Innova™ assisted the builder in deciding which of its systems was most suitable considering the aesthetic that the owner wanted as well as ease of installation and fire resistance.

“I chose Duragoove™ Woodgrain for this project as the timber grain finish provided a good contrast with the Innova™ Stratum™ which we also used on this project. Our tradies love installing these products because they are light, fast and easy to install.”

Ben Ryan  
BR Building



# Case Study 02.

Project: 5 x Affordable Housing Dwellings  
Location: Cloverdale, WA  
Architect/Developer: Modan

**This project targeted the growing co-share market** with primary focus being the FIFO segment so the houses are designed using apartment design principles with flowing spaces, flexibility in the use of rooms and high ceilings.

“We wanted to create buildings which emulate extruded shapes with simple and clean lines. A variety of textures were employed offset with negative space giving balance to the facades. Innova™ Duragroove™ gave us a vertical shadow line contrasting the panel effect of Duragrid™.”

**Arun Broadhurst**  
Modan



# DURAGROOVE™

## WALL CLADDING SYSTEM

### Product Description

Duragroove™ is a strong and durable cladding that has distinctive vertical grooves. Duragroove™ is a factory sealed 9mm flat fibre cement sheet with vertical shiplap profiled edges. Where the sheets join, the result is a 5mm vertical shiplap joint along the 2 long edges.

Duragroove™ is suitable for low to medium rise buildings and can be used on both timber and steel framed buildings. It is also ideal for renovations and alterations to existing dwellings. In smaller areas it provides a distinctive looking feature wall and can be used in either interior or exterior applications.

### Advantages

- / A choice of groove widths and finishes available
- / Has a shiplap joint to ease installation
- / Is lightweight and durable
- / Quick to install as it eliminates the need for taped and filled joints
- / Panels are not affected by termites, air, steam, salt or sunlight

### Sheet Sizes and Weight - Table 1

THICKNESS mm	PROFILE	WEIGHT kg/lm	WIDTH mm	LENGTH mm			
				2450	2750	3000	3600
9	Narrow	13.5	1200	✓	✓	✓	
	Wide			✓	✓	✓	✓
	Extra Wide			✓	✓	✓	
	Woodgrain Wide			✓	✓	✓	
	Woodgrain Extra Wide			✓	✓	✓	

Weights are based on Equilibrium Moisture Content

#### Duragroove™ Narrow

100mm between grooves. 4.5mm width of groove

#### Duragroove™ Wide

150mm between grooves. 4.5mm width of groove

#### Duragroove™ Extra Wide

400mm between grooves. 10mm width of groove

#### Duragroove™ Woodgrain Wide

150mm between grooves. 4.5mm width of groove

#### Duragroove™ Woodgrain Extra Wide

400mm between grooves. 10mm width of groove

### Sheet Tolerances

Duragroove™ complies with the requirements of AS/NZS 2908.2.

### Product Information

Duragroove™ panels are manufactured from Portland cement, finely ground silica, cellulose fibres and water. Panels are cured in a high-pressure steam autoclave to create a durable, dimensionally stable product.

Duragroove™ panels are manufactured to the Australian / New Zealand Standard AS/NZS 2908.2 Cellulose-Cement Products, Part 2: Flat sheets and Duragroove™ is classified as Type A-Category 3.

### Profiles



### Fire Resistance

Our fibre cement products have been tested in accordance with Australian Standard AS1530.3.

These tests deemed the following Early Fire Hazard Indices:

- / Ignition Index 0
- / Spread of Flame Index 0
- / Heat Evolved Index 0
- / Smoke Developed Index 0-1

Duragroove™ is deemed as non-combustible and may be used where a non-combustible material is required.

### Thermal Conductivity

At Equilibrium Moisture Content the approximate thermal conductivity of Duragroove™ is: - 0.33 W/mK.

### Weather Resistance

Duragroove™ conforms to the National Construction Code (NCC) requirements for exterior wall applications.

Duragroove™ has been tested to AS/NZS 4284 Testing of Building Facades.

Duragroove™ that is subject to freeze/thaw conditions must be painted. Duragroove™ should not be used in situations where it will be in direct contact with snow or ice for prolonged periods.



## Moisture Management

Designers, specifiers and builders have a duty of care to identify moisture associated risks with any individual building design.

Wall construction design should consider both the interior and exterior environments of the building to effectively manage moisture. Special consideration should be given to buildings that are in extreme climates or at higher risk of wind-driven rain.

In addition, all wall openings, penetrations, junctions, connections, window heads, sills and jambs must incorporate appropriate flashing for waterproofing. All other components, materials and installation methods used to manage moisture in walls should comply with the relevant standards and the National Construction Code (NCC).

## Durability

The physical properties of Duragroove™ make it a very durable product.

- / Duragroove™ sheets are immune to permanent water damage in both short and long-term exposure.
- / Duragroove™ sheets will not rot or burn and are unaffected by termites, air, steam, salt and sunlight.
- / Duragroove™ sheets are not adversely affected over a temperature range of 0°C to 65°C.

## Vapour Permeable Moisture Barrier

A vapour permeable moisture barrier must be installed in accordance with the AS 4200.2 – ‘Pliable building membranes and underlays – Installation and the vapour permeable moisture barrier manufacturers’ guidelines.

The vapour permeable moisture barrier shall comply to AS 4200.1 and should have the following properties:

- / VCM category – Vapour permeable (Class 3 or Class 4)
- / Water control classification – Water barrier

A vapour permeable moisture barrier is used to prevent moisture ingress by acting as a drainage plane while enabling water vapour build up from inside the frame to escape.

The vapour permeable moisture barrier must be dressed into the return of the framing for penetrations with the edges of the vapour permeable moisture barrier taped down. This must be done prior to the installation of joinery and the like. All joints in the vapour permeable moisture barrier should also be overlapped min.150mm and taped down.

## Flashing

It is a requirement of the NCC to install flashings to all penetrations which includes but not exclusive to windows, doors, meter boxes, intersections etc.

## Cutting and Drilling

Duragroove™ may be cut to size on site. If using power tools for cutting, drilling or sanding they must be fitted with appropriate dust collections devices and an approved P1 dust mask and safety glasses should be worn. It is recommended that work always be carried out in a well ventilated location.

The most suitable cutting methods are:

- / **DURABLADE**  
180mm Diameter.  
This unique cutting blade is ideal for cutting fibre cement. Can be fitted to a 185mm circular saw, ie Makita or similar. Please ensure safe working practices when using.
- / **NOTCHING**  
Notches can be made by cutting the two sides of the notch. Score along the back edge then snap upwards to remove the notch.
- / **DRILLING**  
Use normal high-speed masonry drill bits. Do not use the drill's hammer function. For small round holes, the use of a hole-saw is recommended.

For small rectangular or circular penetrations, drill a series of small holes around the perimeter of the cut out. Tap out the waste piece from the sheet face while supporting the underside of the opening to avoid damage. Clean rough edges with a rasp.

Large rectangular openings are formed by deeply scoring the perimeter of the opening. Next, form a hole in the centre of the opening (refer method above) then saw cut from the hole to the corners of the opening. Snap out the four triangular segments. Clean rough edges with a rasp. (see method above).

## Handling and Storage

Duragroove™ must be stacked flat, up off the ground and supported on equally spaced (min 400mm) level gluts. Care should be taken to avoid damage to the ends, edges and surfaces.

Sheets must be kept dry. When stored outdoors it must be protected from the weather. Sheets must be dry prior to fixing or finishing.

**EXTRA CARE MUST BE TAKEN AT THE SHEET EDGES TO PREVENT DAMAGE OF THE SHIPLAP JOIN.**

## Insulation - Table 2

Timber Framing (with R2.5 batts)		Steel Framing (with R2.5 batts)	
Winter	Summer	Winter	Summer
2.37 (U <sub>T</sub> =0.42)	2.26 (U <sub>T</sub> =0.44)	1.98 (U <sub>T</sub> =0.50)	1.90 (U <sub>T</sub> =0.52)

Total R Values (m<sup>2</sup>K/W) (incorporating thermal bridging in accordance with AS/NZS 4859.1).

Duragroove™ will require insulation to be installed in some regions that have thermal loss regulations. Insulation should be installed in accordance with the manufacturer's instructions. Insulation batt must fit snugly between framing members to minimise heat loss.

# DURAGROOVE™

## WALL CLADDING SYSTEM

### Health and Safety

Duragroove™ is manufactured from cellulose fibre, finely ground sand, Portland cement and additives. As manufactured, the product will not release airborne dust, but during drilling, cutting and sanding operations cellulose fibres, silica and calcium silicate dust may be released.

Breathing in fine silica dust is hazardous and prolonged exposure (usually over several years) may cause bronchitis, silicosis or cancer.

### Avoid Inhaling Dust

When cutting sheets, work in a well ventilated area and use the methods recommended in this literature to minimise dust generation. If using power tools wear an approved (P2) dust mask and safety glasses.

These precautions are not necessary when stacking, unloading or handling fibre cement products.



For a copy of our Safety Data sheet or Working Safely with Fibre Cement brochure contact the nearest Sales Office or go to [www.innovafibreceement.com.au](http://www.innovafibreceement.com.au)

### Coastal Areas

The durability of galvanised nails and screws used for exterior cladding in coastal or similar corrosive environments can be as low as 10 years.

For this reason we recommend the use of stainless steel or min. class 4 fasteners within 1km of the coast or other large expanses of salt water.

### Accessories available

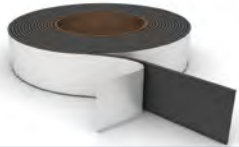
INTERNAL ALUMINIUM CORNER	3000mm	PRODUCT CODE INTCNR12	
EXTERNAL ALUMINIUM CORNER	3000mm	PRODUCT CODE EXTCNR12	
ALUMINIUM HORIZONTAL FLASHING	3000mm	PRODUCT CODE HORIZ9	
EXTERNAL SNAP ON CORNER - PART A	3600mm	PRODUCT CODE SNAPCNR36	
EXTERNAL SNAP ON CORNER - PART B	3600mm	PRODUCT CODE SNAPCNRB36	
DURAGROOVE™ JOINER (To be used when a vertical control joint as required)	3000mm x 12mm	PRODUCT CODE STRJNR12	
EPDM FOAM GASKET (Used to prevent moisture ingress at sheet joints).	25m	PRODUCT CODE 845	
THERMAL BREAK TAPE	12.5m	PRODUCT CODE THERMAROLL12.5	

## Fasteners - Supplied by others

### Duragroove™ to timber frame

Min. Class 3 2.8 x 40mm fibre cement nail



Min. Class 3 2.8 x 40mm Cladfast gun nail



Stainless 14G 50mm ND brad



- / Nails must be driven flush to the panel surface.
- / Nails must be driven a minimum of 30mm into the frame.
- / Care is needed when using nail guns. If variability occurs the gun should be set to under drive and the nails tapped home with a hammer.
- / Fasteners in coastal areas must be either stainless steel or min. class 4.

## Fasteners - Supplied by others

### Duragroove™ to steel frame

0.55-0.75BMT Min. Class 3 8 x 30mm countersunk screw



0.75-1.6BMT Min. Class 3 8 x 40mm wingtek countersunk screw



### PARAPET CAP FLASHING TO FRAME

Min. Class 3 hex head 12-14 x 30mm with neoprene washer - 600mm centres



### PRE COUNTERSINK

When using screws to fasten Duragroove™, pre-countersinking is suggested so that the fastener is 1.5mm under the sheet surface for filling with Megapoxxy P1 or similar 2 part epoxy paste and Exterior Finishing Compounds.

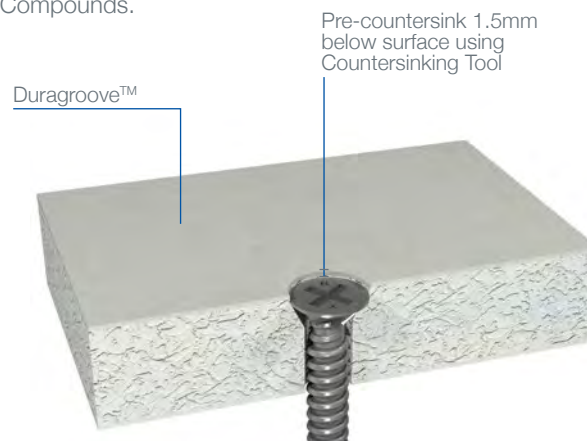

### Construction Details

#### Framing

Duragroove™ panels must be installed vertically to both timber and lightweight steel frames.

Ensure that the frame is square and work from a central datum line. The frame must be straight and true to provide a flush face to receive the panels.

We recommend a maximum tolerance of 3mm-4mm in any 3000mm length of frame.

Duragroove™ will not straighten excessively warped or distorted frames and any warping may still be visible after Duragroove™ is applied. Warped framing will require remedial action.

#### Timber Frames

Use of a timber frame must be in accordance with AS1684 – Residential timber-framed construction and the framing manufacturers' specifications.

Use only seasoned timber. Do not use unseasoned timber as it is prone to shrinkage and can cause excessive movement.

Framing width at sheet joints must be min. 45mm wide, double studs at some joins may be required.

"Timber used for house construction must have the level of durability appropriate for the relevant climate and expected service life conditions including exposure to insect attacks or to moisture which could cause decay" – Reference AS1684.2

#### Lightweight Steel Frames

Use of steel frame must be in accordance with AS3623 – Domestic metal framing and the framing manufacturers' specifications.

Framing members must have a Base Metal Thickness (BMT) between 0.5 to 1.6mm. The steel framing must have the appropriate level of durability required to prevent corrosion.

The framing width at sheet joints must be a minimum of 50mm. The intermediate support studs should be a minimum of 64 x 35mm.



Figure 1  
Frame Straightness

### Fixing and Framing Requirements – Timber & Steel Framing - Table 3

Wind Classification AS4055	Max. Design Ultimate Limit State Wind Pressure AS/NZS 1170.2		Within 1200mm of corners (mm)		General Areas of Walls (Away from Corners) (mm)		Timber Framing	Steel Framing
	Within 1200mm of corners - kPa	General areas of walls - kPa	Stud Spacing	Fastener Spacing	Stud Spacing	Fastener Spacing	AS 1684 or AS 1720.1	NASH Standard
N1	-0.94	-0.53, +0.62	600	200	600	200	40mm Galv. Flat Head Nails or screw-fixed <sup>(7)</sup>	#10-18 x30mm Fibretek
N2	-1.30	-0.74, +0.86	600	200	600	200		
N3	-2.42	-1.16, +1.35	600	200	600	200		
N4	-4.02	-1.72, +2.01	450	200	600	200		
N5	-4.27	-2.14, +2.30	450(Timber) 300(Steel)	150	450	180	screw-fixed only <sup>(7)</sup>	
N6	-5.77	-2.88, +3.11	300	150	450	135		
C1	-2.84	-1.94, +2.08	450	200	450	200	40mm Galv. Flat Head Nails or screw-fixed <sup>(7)</sup>	
C2	-4.02	-3.10, +3.34	450	200	450	200		
C3	-4.27	-2.14, +2.30	300	150	450	180	screw-fixed only <sup>(7)</sup>	
C4	-5.77	-2.88, +3.11	300	150	450	135		

#### NOTES:

- For Weatherproofing in N1, N2, N3, N4, C1, C2, use either AS 4200.1 vapour permeable moisture barrier; or Durabarrier Rigid Air Barrier System.
- For Weatherproofing in N5, N6, C3, C4, use Durabarrier Rigid Air Barrier System.
- All sheet edges must be supported on structural framing (noggings are typically not suitable structural framing)
- Fixings shall be minimum 12mm from sheet edges & 50mm from sheet corners.
- All fixing lengths shall be increased by 6mm when used in conjunction with Durabarrier Rigid Air Barrier System.
- Steel Framing in shall be; min. 0.55mm BMT G550 for N1 to N3; min. 0.75mm BMT G550 for N4-N6 & C1 to C4.
- Screw fixings to timber framing shall be at minimum #10-8 Fibre Cement Class 4 with minimum 35mm embedment into the timber framing and shall be pre-drilled and countersunk with Countersinking Tool.

## Fixing Table 50mm ND Brads to Timber Framing - Table 4

Wind Classification AS4055	Max. Design Ultimate Limit State Wind Pressure AS/NZS 1170.2		Within 1200mm of corners (mm)		General Areas of Walls (mm)		Timber Framing
	Within 1200mm of corners - kPa	General areas of walls - kPa	Stud Spacing	Fastener Spacing	Stud Spacing	Fastener Spacing	
N1	-0.94	-0.53, +0.62	600	100	600	100	Suitable
N2	-1.30	-0.74, +0.86	600	100	600	100	
N3	-2.42	-1.16, +1.35	600	100	600	100	
N4	-3.01	-1.72, +2.01	450	100	450	100	

### NOTES:

- For Weatherproofing in N1, N2, N3, N4, C1, C2, use either AS 4200.1 vapour permeable moisture barrier; or Durabarrier Rigid Air Barrier System.
- All sheet edges must be supported on structural framing (noggings are typically not suitable structural framing)
- ND Brads shall be minimum 12mm from sheet edges and 50mm from sheet corners.
- All fixing lengths shall be increased by 6mm when used in conjunction with Durabarrier Rigid Air Barrier System.

## Installation Details

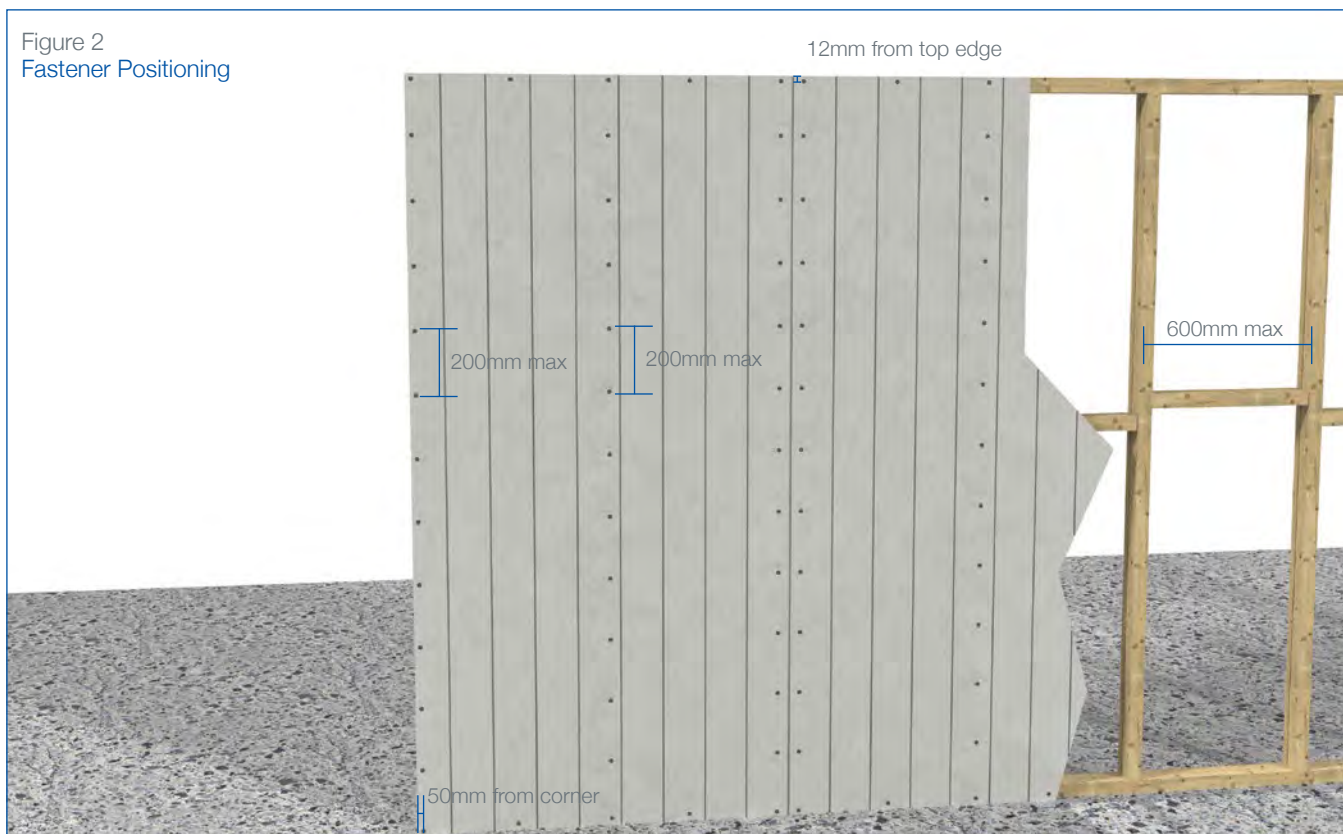

Duragroove™ panels should be installed vertically with all sheet edges fully supported. The centre joints must coincide with the centre lines of the framing member and all sheets should be installed in one direction.

## Installation Details

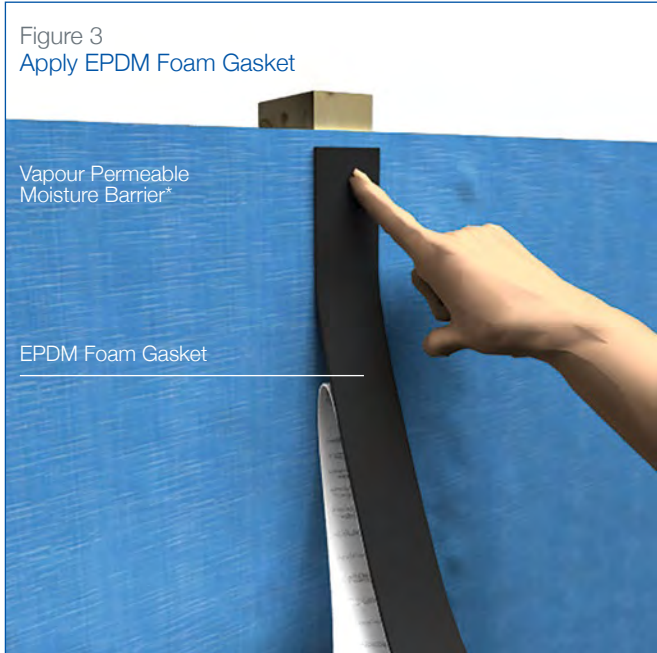

At every vertical joint, fix a continuous strip of EPDM Foam Gasket to the vapour permeable moisture barrier along the stud. This creates a compressive seal to prevent moisture ingress at the sheet joints.

As detailed on page 11, there are several different fasteners that can be used to fix Duragroove™.

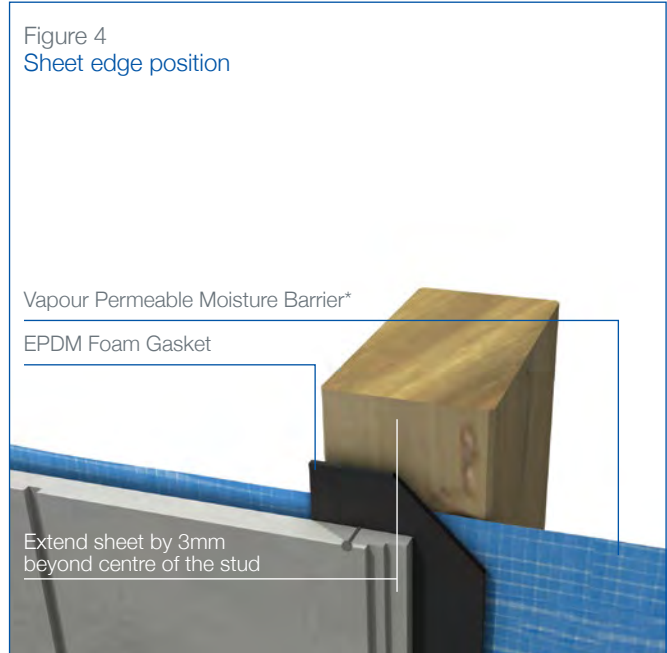

Position the underlap sheet on every stud 3mm beyond the centre of the stud to ensure the fasteners fixed at the edge of the sheet have adequate distance into the stud.

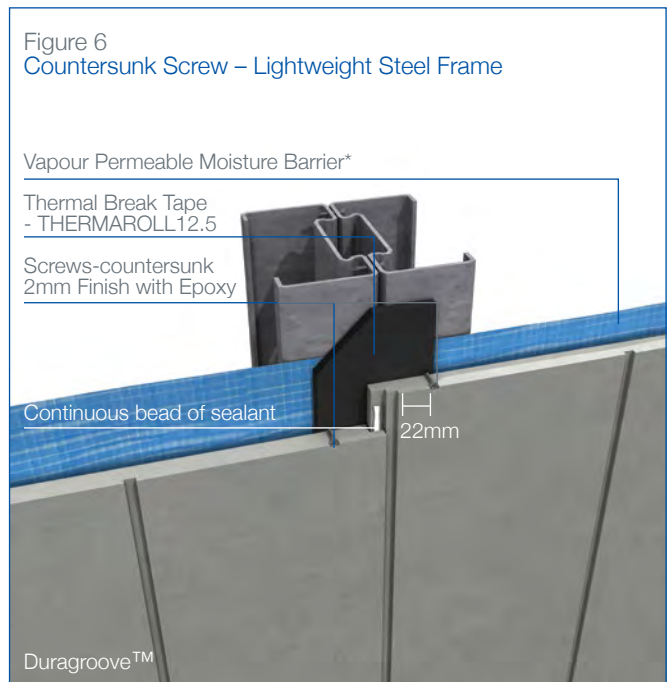
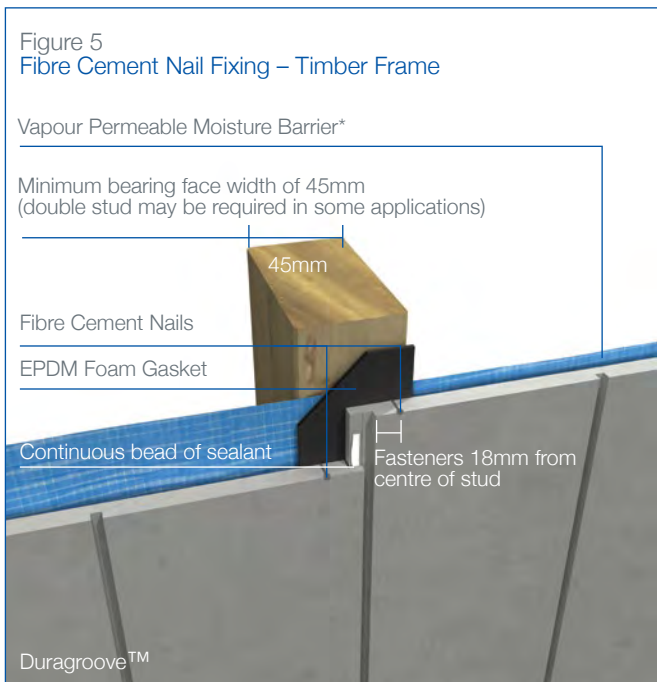

## Installation Details

To fix the first sheet, set in place ensuring the required edge distances are maintained.

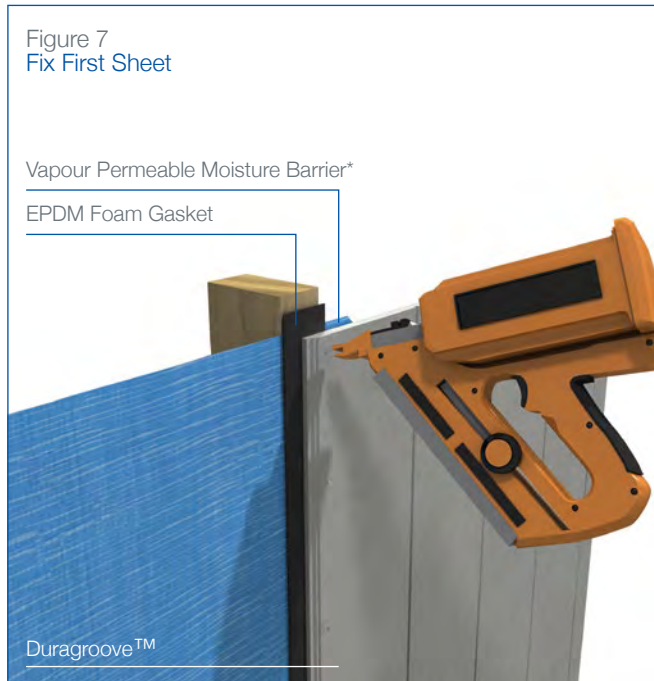

Apply a continuous 4mm bead of Polyurethane sealant to the edge of the shiplap joint.



## Installation Details

The architectural intent and details of buildings vary from one designer to the next and the variety of wall cladding details would be impossible to catalogue.

The designer should not digress from the specification set out in this manual.

The following detailed diagrams are intended to assist the designer in achieving a high quality weather resistant Duragroove™ installation.

Figure 10  
Bottom Plate

Primary frame (timber/steel)\*

Vapour Permeable Moisture Barrier\*

Duragroove™

Flashing tape\*

Damp Course\*

100-150mm clearance from earth,  
50mm clearance from finished  
surface e.g. paving/concrete.

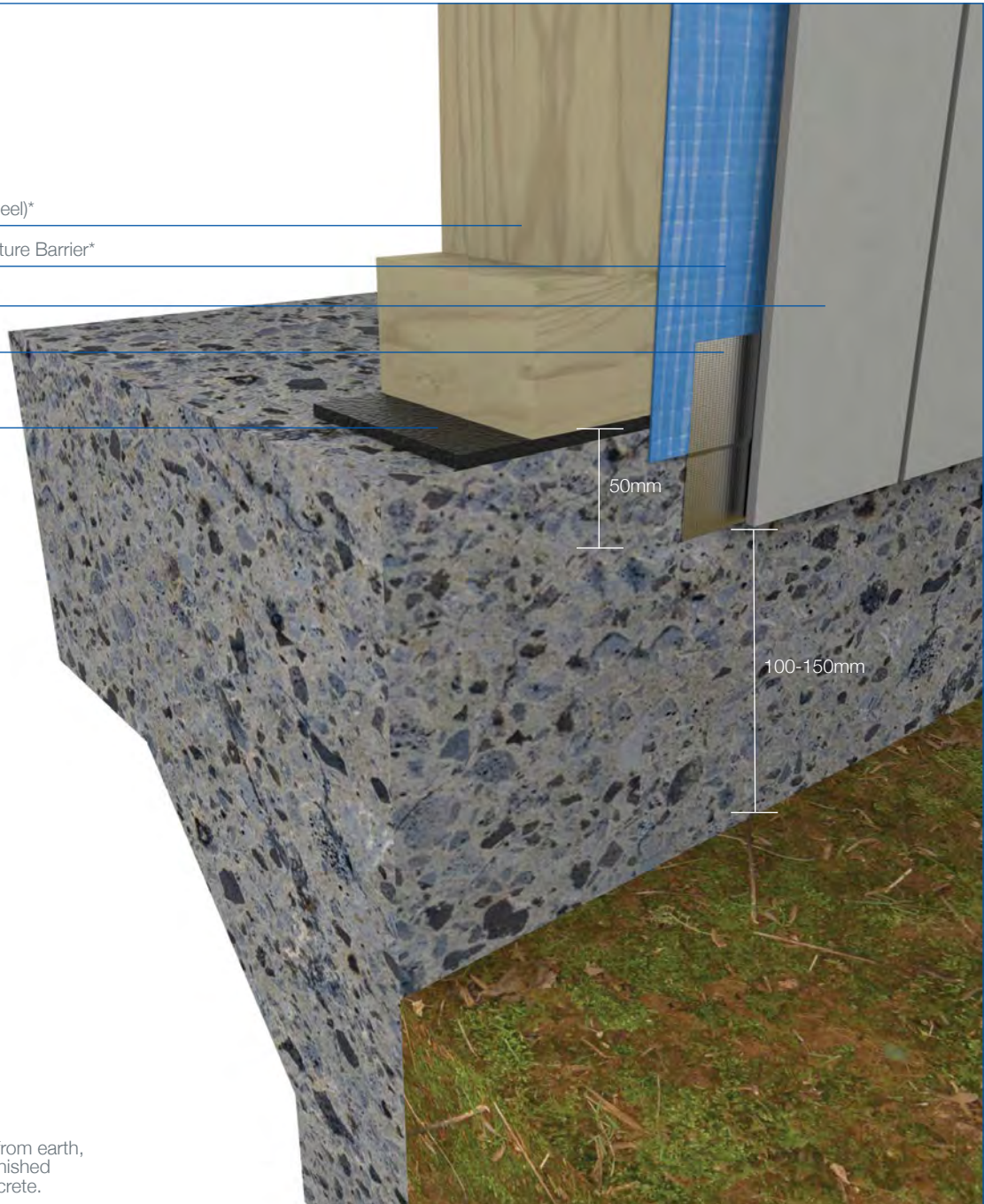



## Installation Details

Figure 11  
External Corner

Primary frame (timber/steel)\*

Vapour Permeable Moisture Barrier\*

Continuous 6-8mm bead  
of polyurethane sealant

12mm Aluminum External Corner  
(EXTCNR12)

Duragroove™

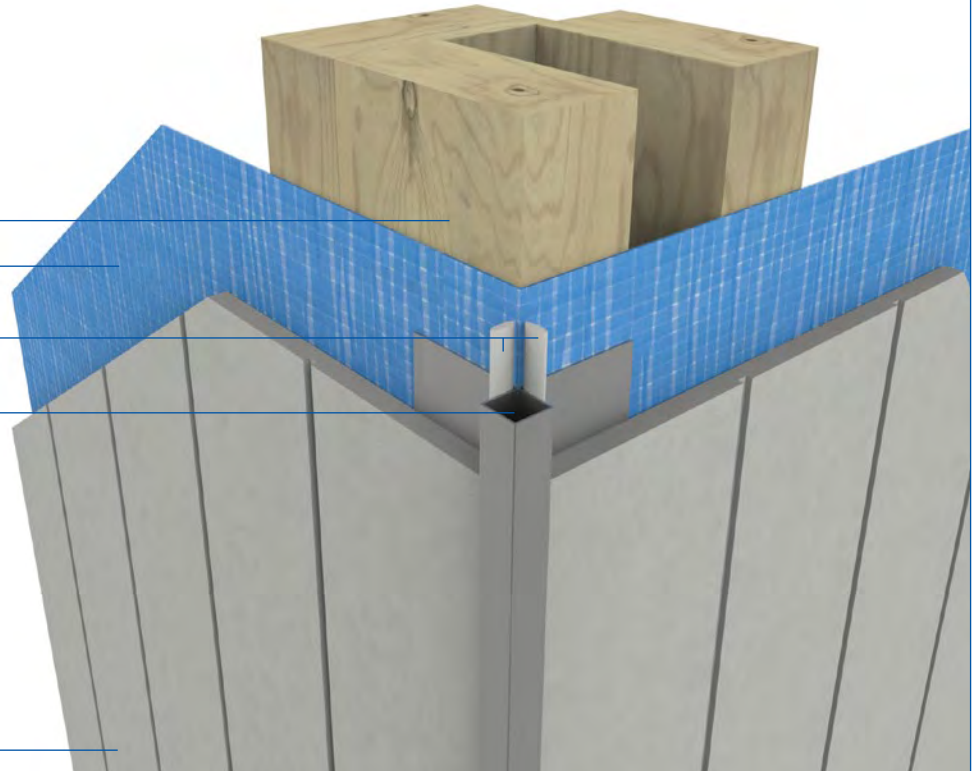

Figure 12  
External Corner Butt/Lap

Primary frame (timber/steel)\*

Vapour Permeable Moisture Barrier\*

30 x 30 x .55 BMT flashing\*

Bond Breaker Tape\*

Continuous 6-8mm bead  
of polyurethane sealant

Duragroove™

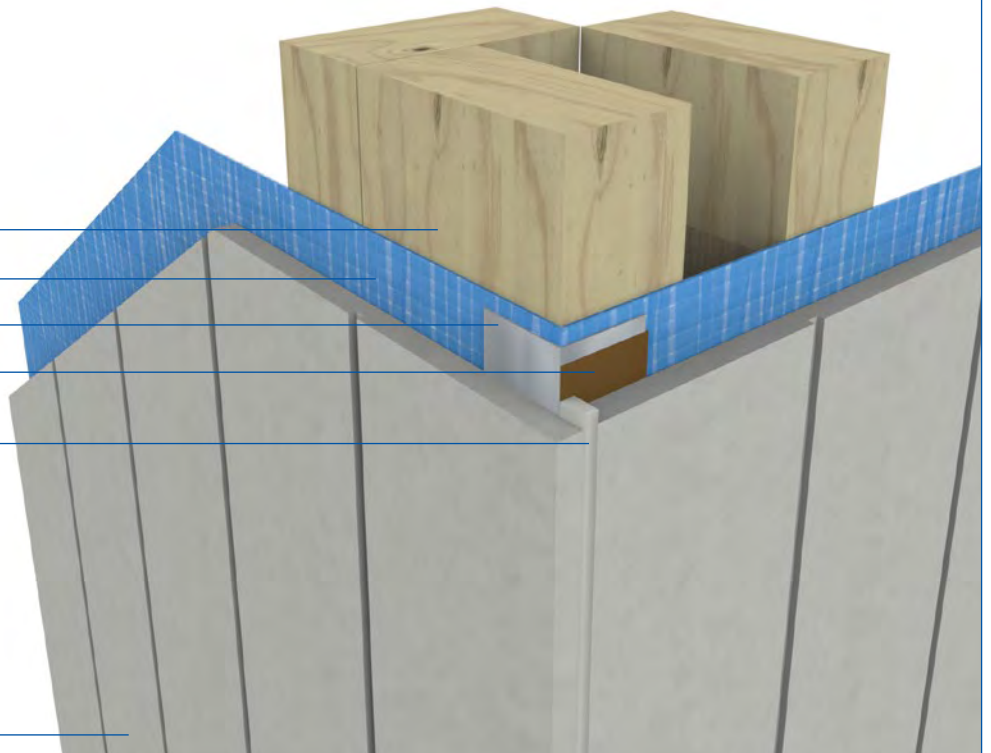

## Installation Details

Figure 13  
Internal Corner

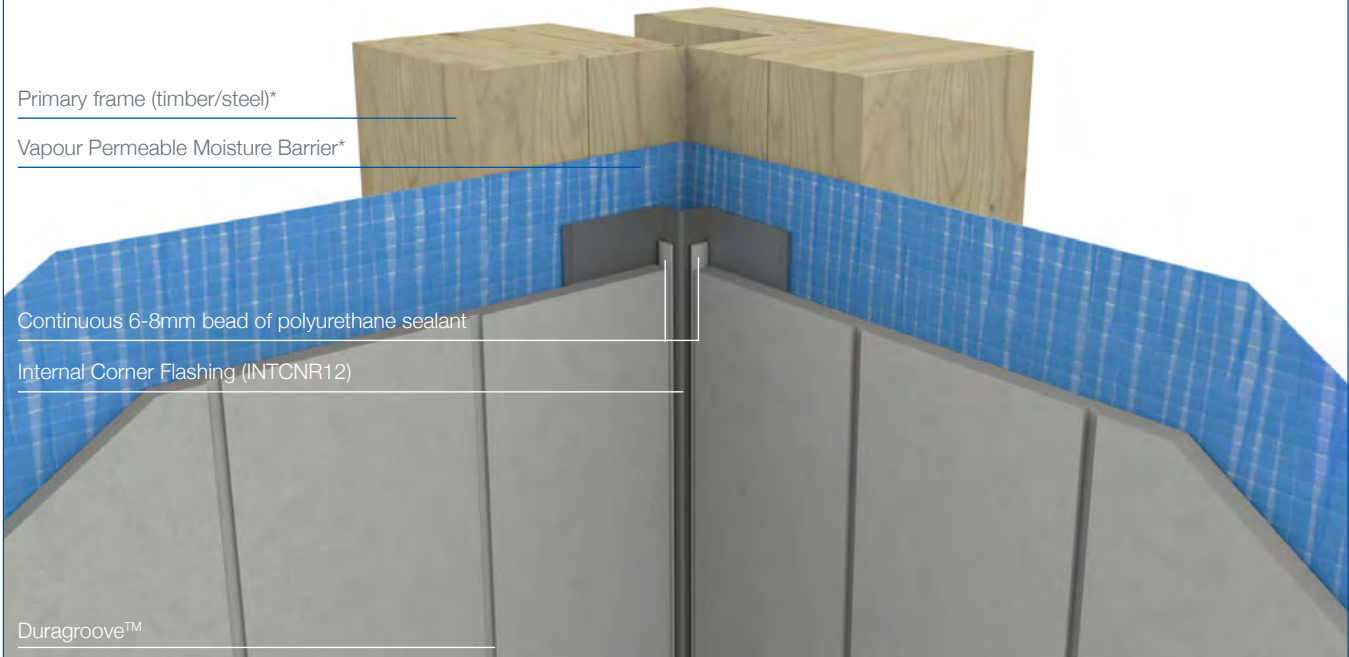
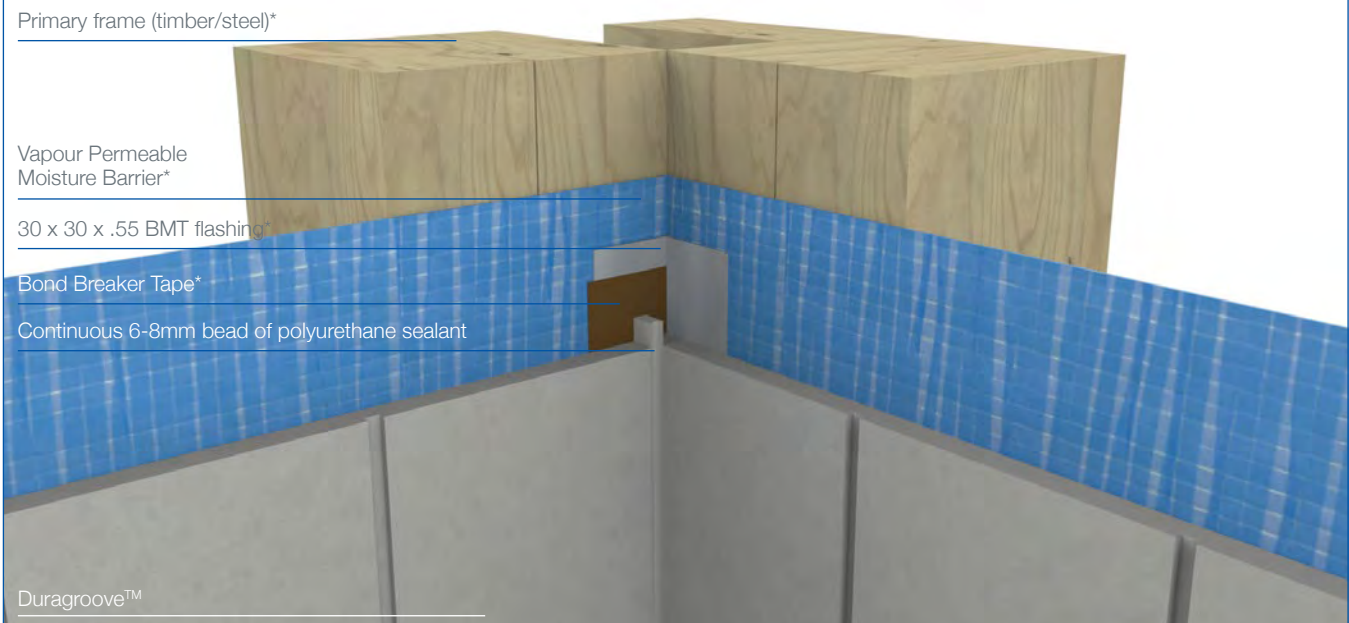
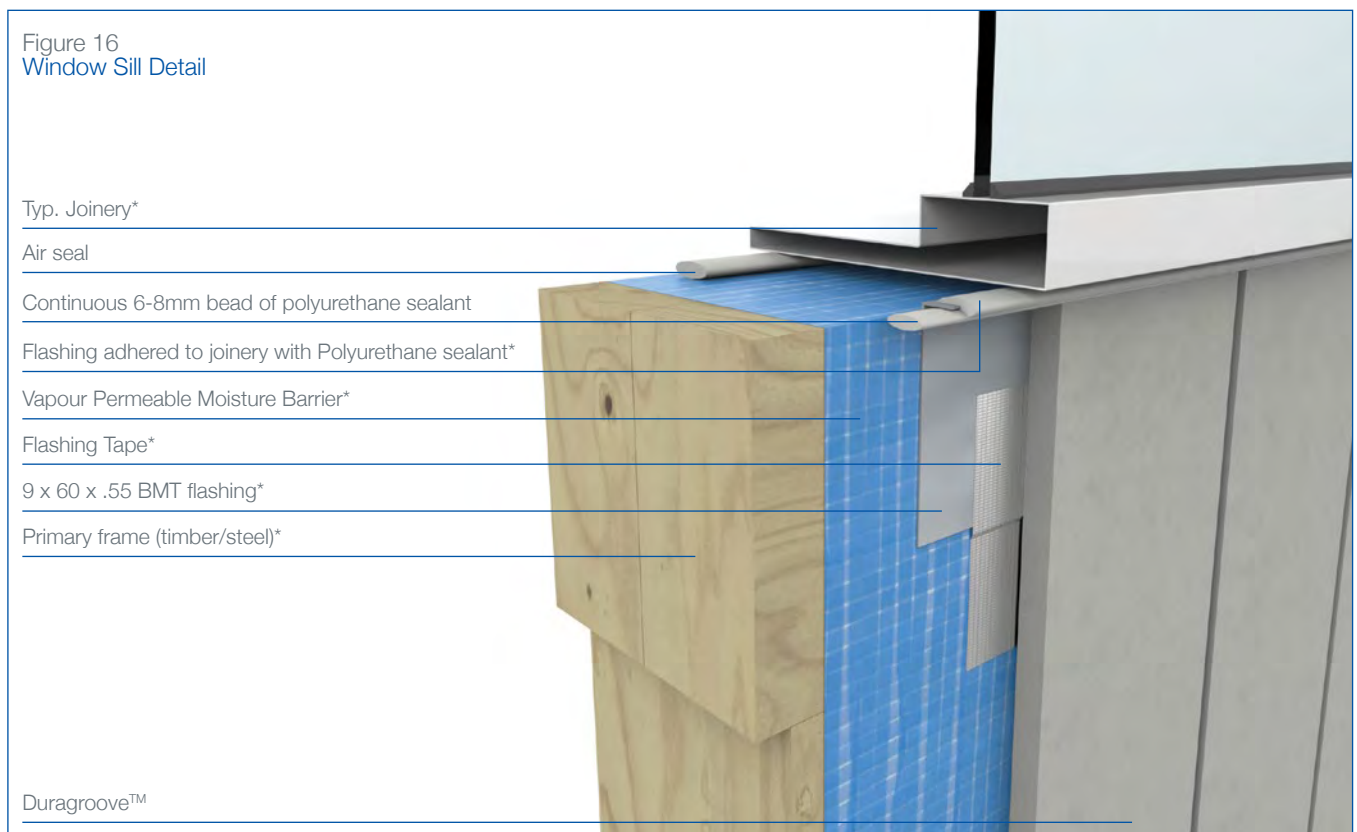
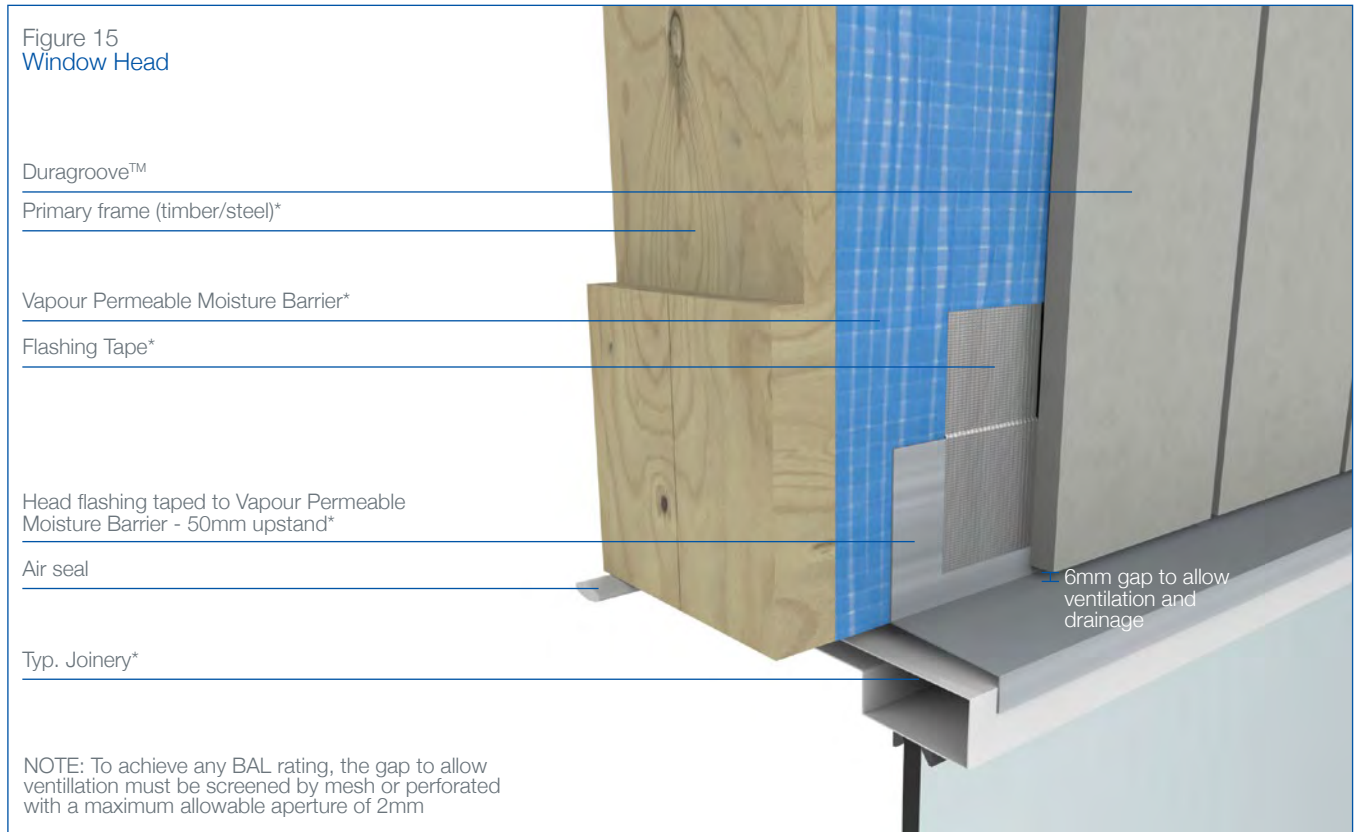

Figure 14  
Internal Corner Butt/Lap



## Installation Details



Installation Details

Figure 17  
Window Jamb

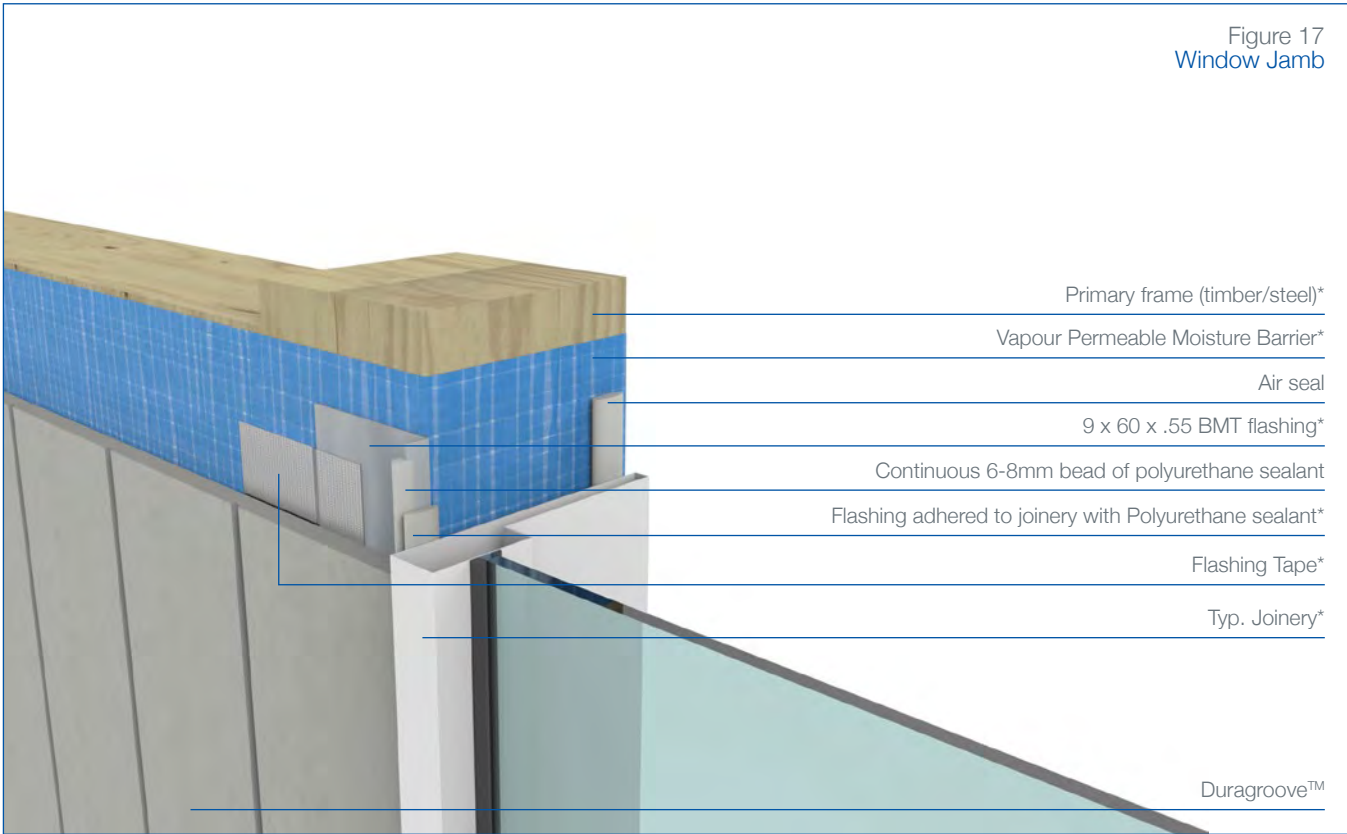

Figure 18  
Meter Box Head and Sill

Flashing Tape\*

60 x 10 x .55 BMT flashing\*

Continuous 6-8mm bead of polyurethane sealant

Flashing adhered to meterbox with Polyurethane sealant

Primary frame (timber/steel)\*

Air seal

Duragroove™

Airseal

Flashing adhered to joinery with Polyurethane sealant

60 x 10 x .55 BMT flashing\*

Flashing tape\*

Vapour Permeable Moisture Barrier\*

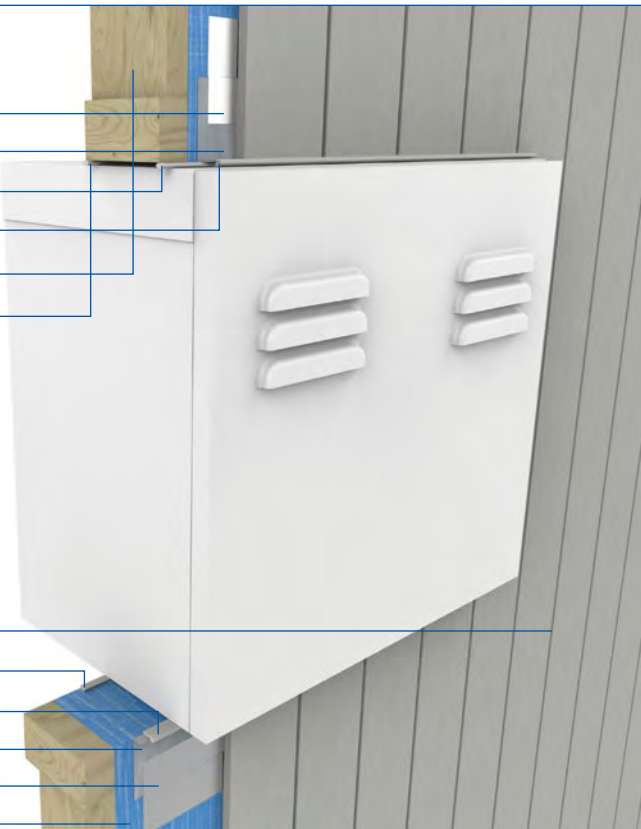

## Installation Details

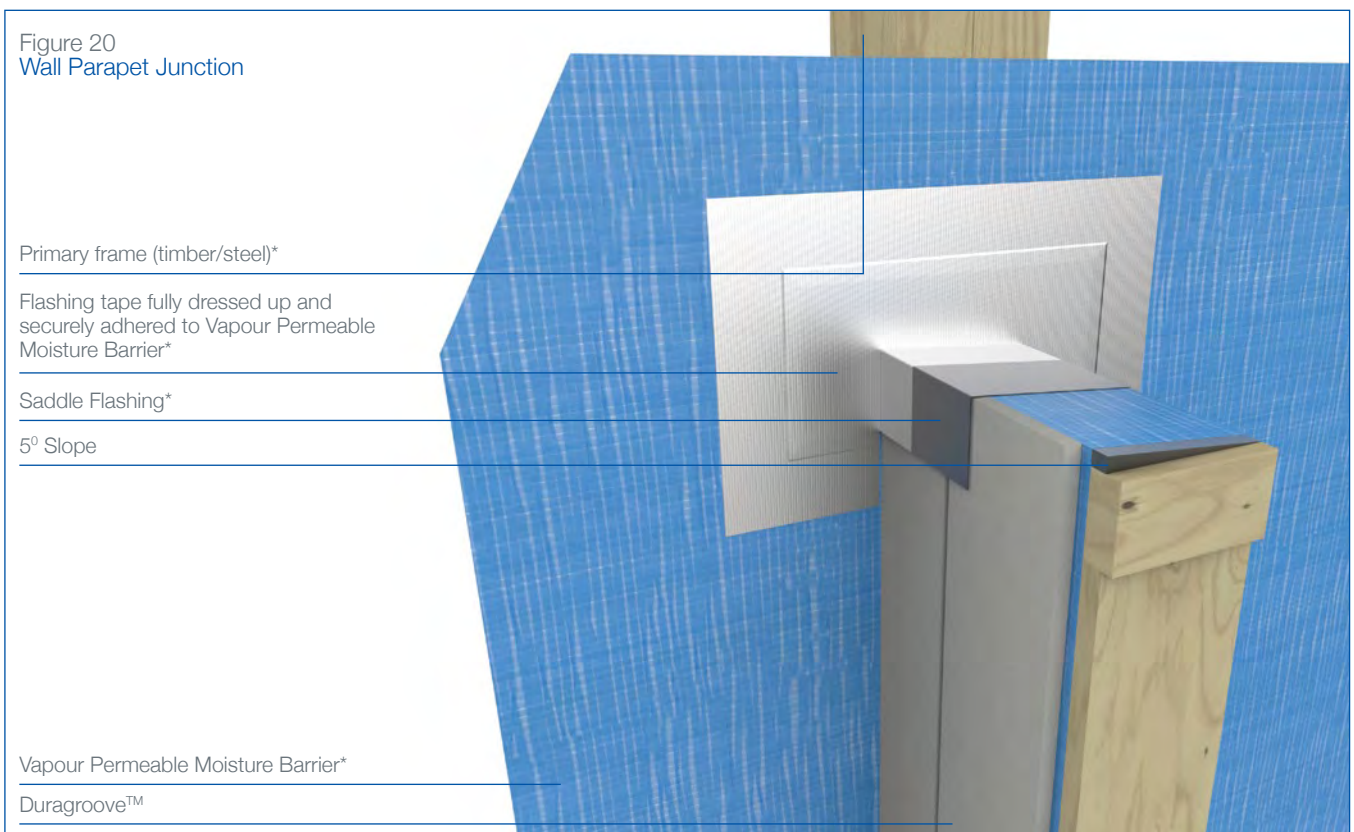

Installation Details

Figure 21  
Scupper Outlet

Primary frame (timber/steel)\*

Vapour Permeable Moisture Barrier\*

Flashing Tape\*

Continuous 6-8mm bead of polyurethane sealant

Scupper Outlet\*

Continuous 6-8mm bead of polyurethane sealant

Flashing Tape\*

Duragroove™

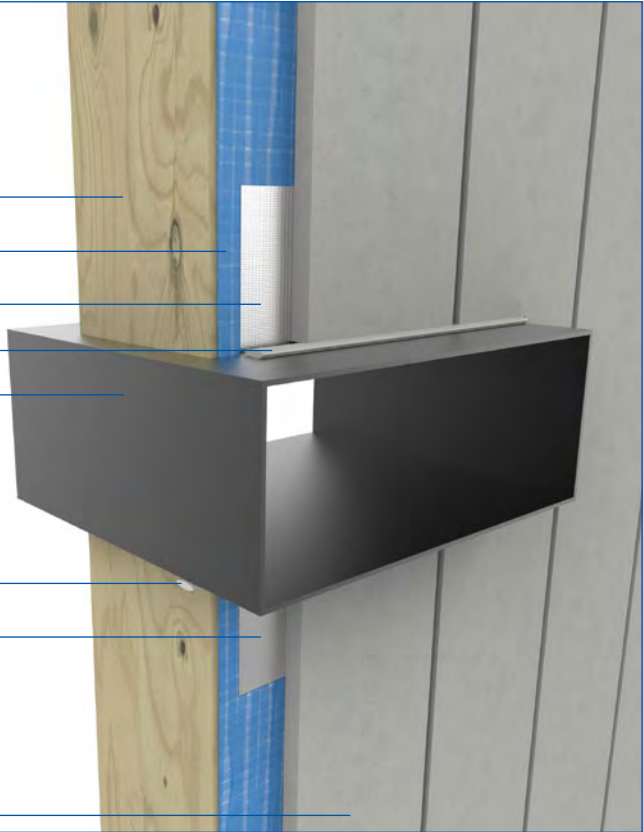

Figure 22  
Mid Floor Junction - Horizontal Control Joint

Primary frame (timber/steel)\*

Flashing Tape\*

Vapour Permeable Moisture Barrier\*

Flooring\*

Aluminium Horizontal Flashing (HORIZ9)

Continuous 6-8mm bead of polyurethane sealant

Floor Joist\*

Duragroove™

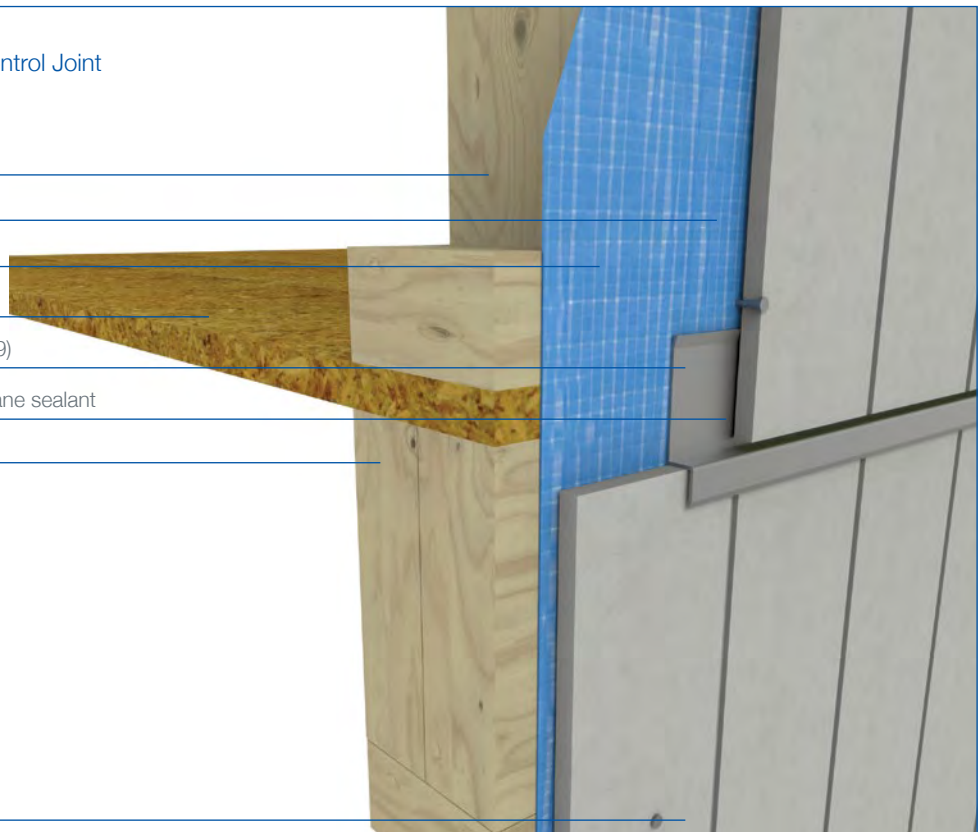

## Installation Details

Figure 23  
Vertical Control Joint

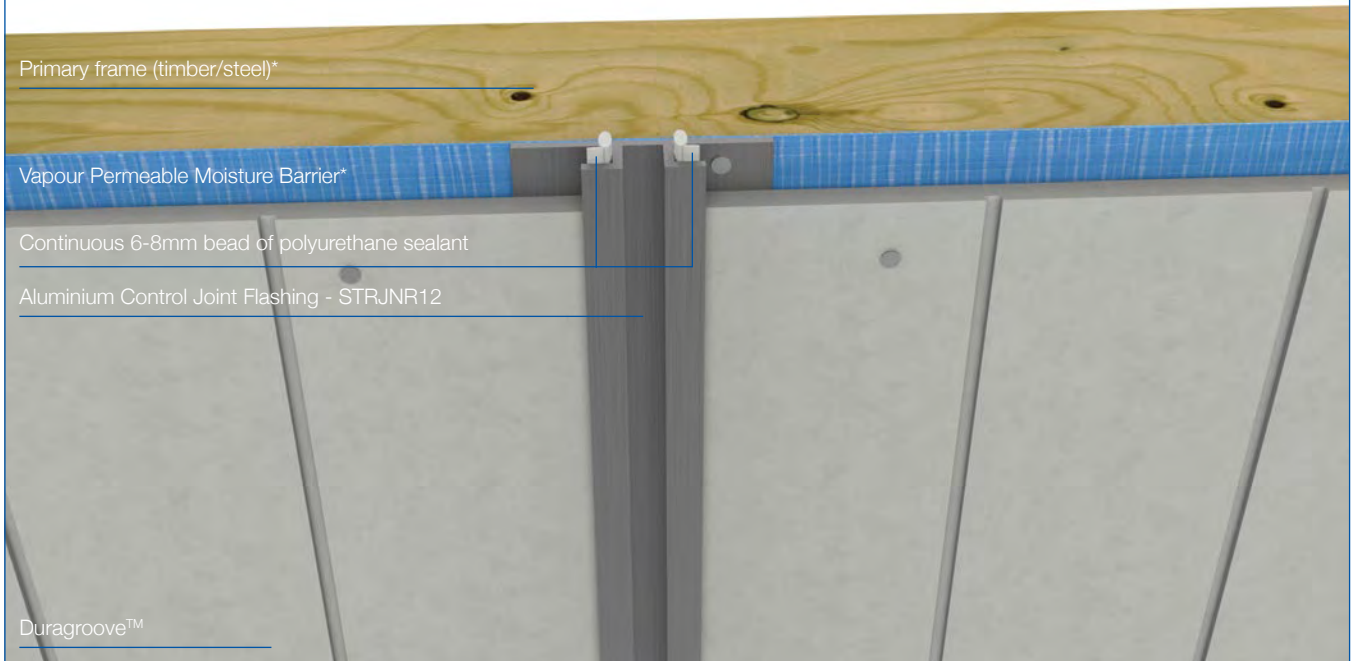
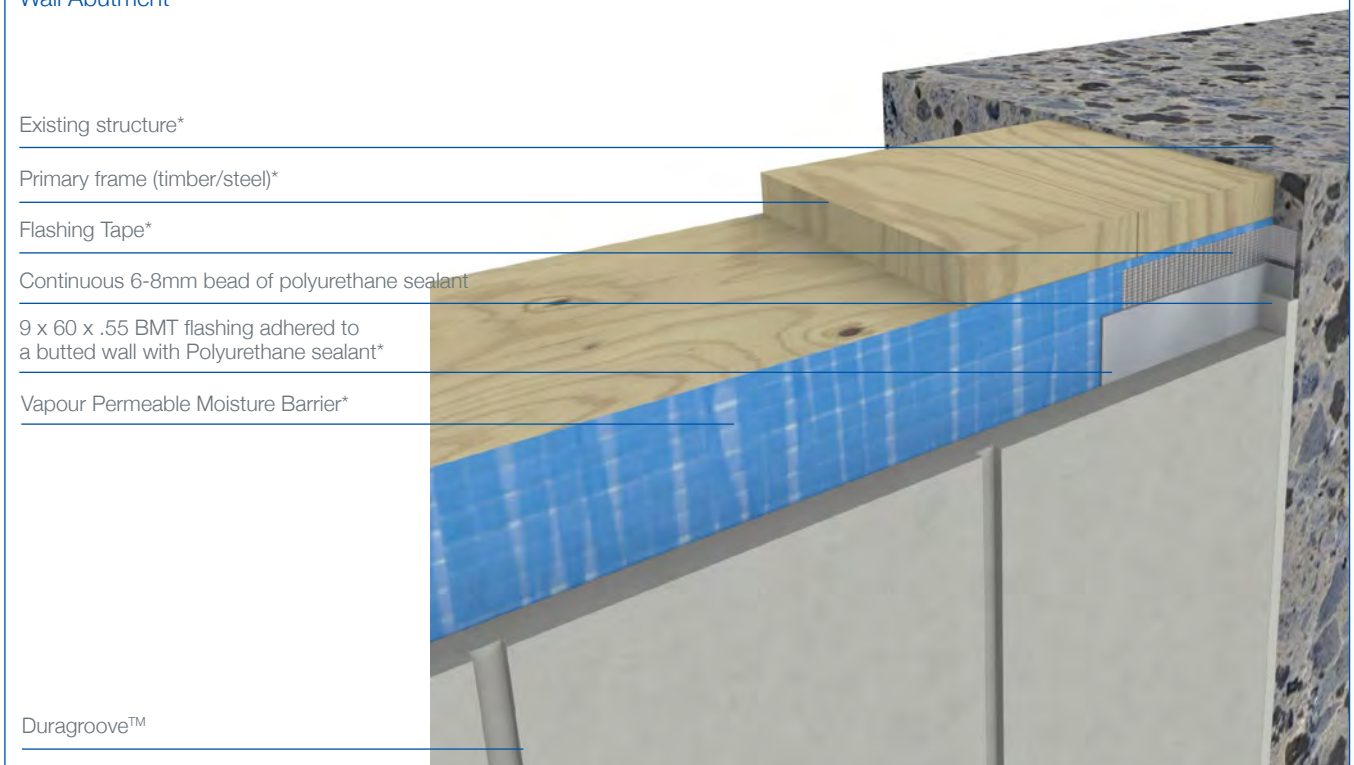

Figure 24  
Wall Abutment



## Thermal Breaks - Steel Frame

Thermal breaks may be required for steel framed buildings, in walls that are required to have a minimum total R value. Careful consideration of thermal heat transfer and the position of thermal breaks need to be addressed by the architects, engineers and building designers.

Balustrades, parapets, and other non-enclosing wall elements may not require thermal breaks, except where the possibility of high thermal heat transfer exists through the steel sections to the main structural steel element of the building.

Thermal breaks are required to have an R value of R0.2 in order to meet the NCC requirement for a Thermal Break.

Figure 25  
Thermal Breaks

Steel frame\*

Thermal Break Tape\* - THERMAROLL12.5

Vapour Permeable Moisture Barrier\*

Duragroove™

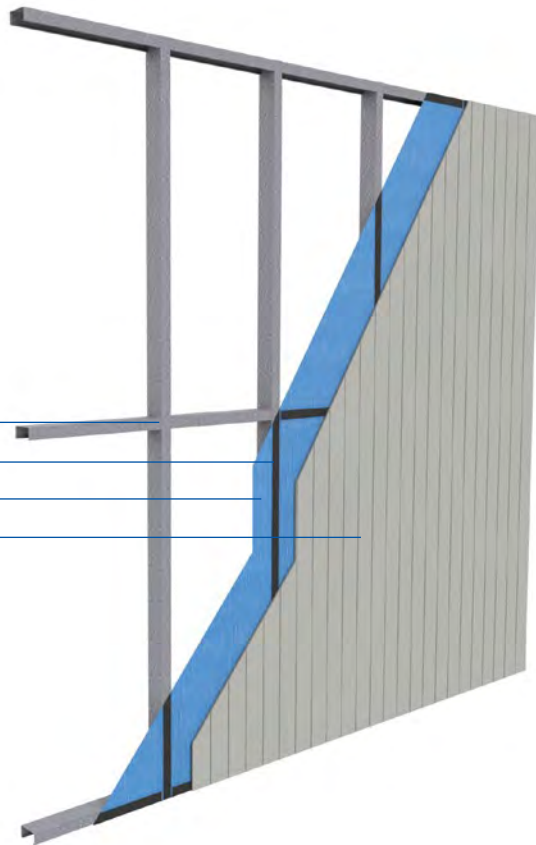



## Bushfire and Boundary Wall Areas

AS3959 sets out a series of bushfire threat levels to buildings described as BAL (Bushfire Attack Levels) as follows: BAL-Low, BAL-12.5, BAL-19, BAL-29, BAL-40 or BAL-FZ (Flamezone).

Duragroove™ is eminently suited for both bushfire and boundary wall applications in residential and multi-residential buildings.

### Bushfire AS3959:2018 Applications

Duragroove™ may be used as a stand-alone product to achieve up to BAL 40 when fixed direct to frame as per the fixing instructions in this manual.

Duragroove™ when used in conjunction with GTEK™ Fire and Wet Area 16mm will comply with the requirements of AS3959 and AS1530.4 to achieve BAL FZ>10.

### Boundary/Exterior Walls

Duragroove™ in conjunction with GTEK™ Fire and Wet Area 16mm can achieve both 60/60/60 and 90/90/90 FRL fire ratings from the outside as required by the NCC.

In timber and steel frame applications where an exterior wall is required to achieve 60/60/60 FRL, 1 layer of GTEK™ Fire and Wet Area 16mm, installed with the Duragroove™ to the outside walls as well as GTEK Wall 10mm on the inside will achieve this result.

Similarly, 2 layers of GTEK™ Fire and Wet Area 16mm used in conjunction with Duragroove™ will achieve 90/90/90 from the outside on both timber and steel frame.

**NOTE: All exterior walls must have vapour permeable moisture barrier directly behind the Duragroove™.**

No adhesives are to be used when installing GTEK™ Fire and Wet Area 16mm and the Duragroove™ Nails or screws must be used.

For more information please contact the technical team on 1300 652 242 or contact us through our website. Refer to GTEK™ Fire and Acoustic Guide for installation of fire rated plasterboard.

Figure 26  
Boundary Wall System

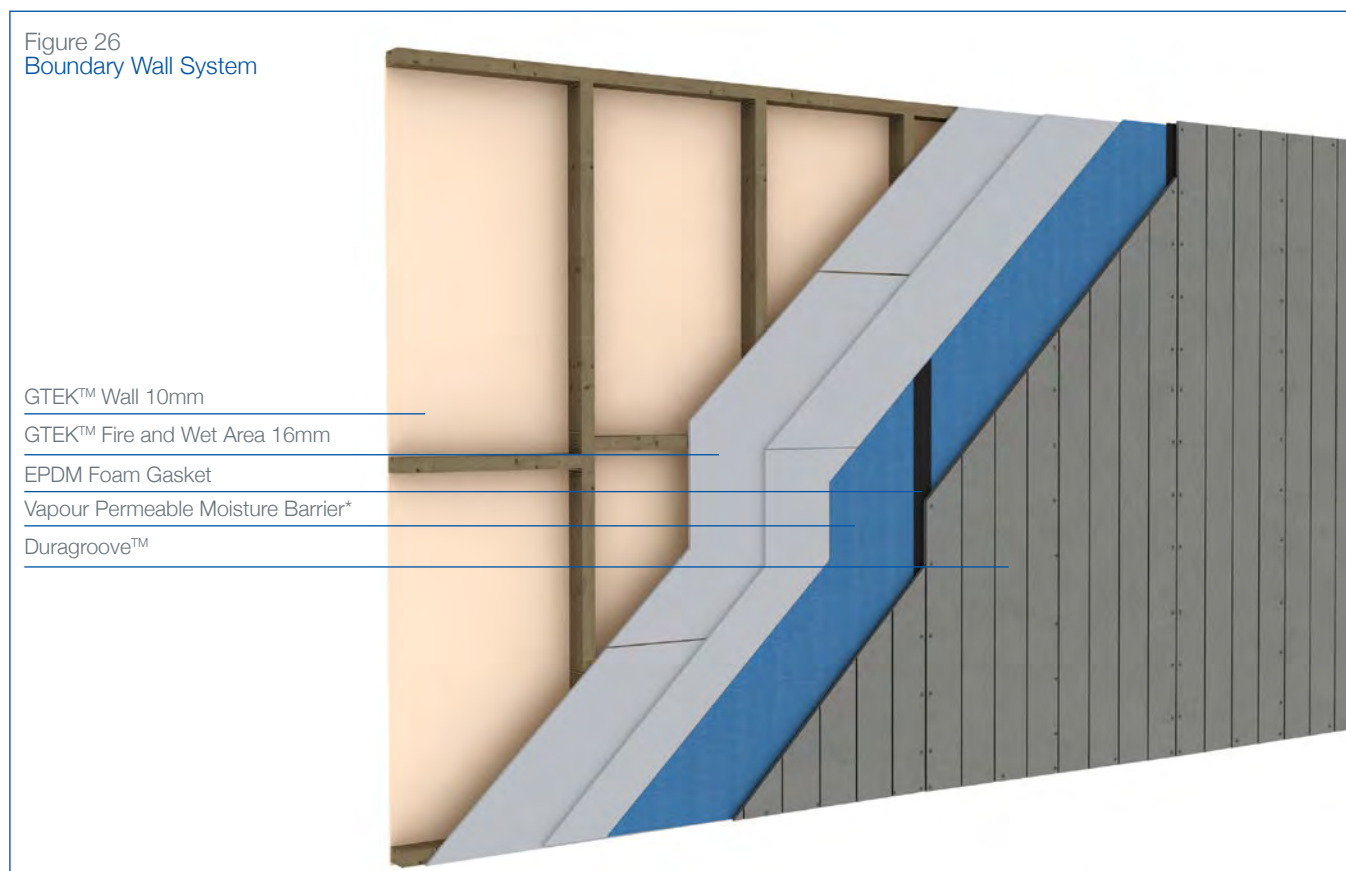

# DURAGROOVE™

## WALL CLADDING SYSTEM

### Painting

To enhance both the appearance and performance of Duragroove™, we recommend that at least two coats of 100% acrylic exterior grade paint be applied. The paint manufacturer's recommendation on application and maintenance of the paint system should be followed.

It is recommended that Duragroove™ is painted according to the paint manufacturer's instructions within three months following delivery to site.

Should Duragroove™ be exposed to the elements for a period beyond the initial three months to achieve an optimum finish an additional priming coat is recommended prior to the top finishing coats being applied.

Ensure that Duragroove™ is dry and clean prior to applying a quality exterior paint system.

Gloss paint finishes are not recommended.

**Note: we recommend the use of a roller or brush application for best results.**

### Maintenance

Duragroove™ when used in accordance with this literature requires no direct maintenance.

To guard against water penetrating the structure and damaging the framework, annual inspections of the cladding system should be carried out. Check flashing, sealant joints and paint work.

Flashings and sealants must continue to perform their design function.

Damaged sheets should be replaced as originally installed. Paintwork should be maintained in accordance with the manufacturer's instructions.

### Deemed to Comply

The NT Deemed to Comply Manual (DTCM) is referenced in the NCC Volume 2 Part H7D1 - Deemed to Satisfy Provisions as an acceptable construction manual for high wind areas.

Duragroove™ is suitable to be used in high wind environments and is Deemed to Comply - M-375-01

For an up-to-date and complete list of products that are 'Deemed to Comply' please refer to [www.ntlis.nt.gov.au/deemedtocomply](http://www.ntlis.nt.gov.au/deemedtocomply)

### Warranty

We warrant that our products are free from defects caused by faulty manufacture or materials for the following period from the date of purchase:

- 25 years for the Nuline™ Plus, Stratum™ and Duraplank™ ranges
- 10 years for the Montage™ range and
- 15 years for all other Innova™ Fibre Cement ranges

If you acquire any defective products, we will repair or replace them, supply equivalent replacement products or refund the purchase price within 30 days of receiving a valid claim, subject to product inspection and confirmation of the existence of a defect by Innova™. We will bear the cost of any such repair, replacement or refund.

This warranty is given by:

#### **Etex Australia Pty Ltd**

31 Military Road, Matraville, NSW 2036  
Phone 02 9311 6908

To claim under this warranty, you must provide proof of purchase as a consumer and make a written claim (including any costs of claiming) to us at the address specified above within 30 days after the defect was reasonably apparent, or if the defect was reasonably apparent prior to installation, the claim must be made prior to installation. You may not claim under this warranty for loss or damage caused by:

- faulty or incorrect installation by non-Innova™ installers (Innova™'s installation procedures are at [www.innovafibreceement.com.au](http://www.innovafibreceement.com.au));
- failure to comply with the Building Code of Australia or any applicable legislation, regulations approvals and standards;
- products not made or supplied by Innova™;
- abnormal use of the product; or
- normal wear and tear.

The benefits available under this warranty are in addition to other rights and remedies of the consumer under the law. Our goods come with guarantees that cannot be excluded under the Australian Consumer Law. You are entitled to a replacement or refund for a major failure and for compensation for any other reasonably foreseeable loss or damage.

You are also entitled to have the goods repaired or replaced if the goods fail to be of acceptable quality and the failure does not amount to a major failure.



**Adelaide**  
Telephone  
08 8480 1700

**Brisbane**  
Telephone  
07 3548 8400

**Melbourne**  
Telephone  
03 9492 1700

**Perth**  
Telephone  
08 9311 5500

**Sydney**  
Telephone  
02 8107 9500

**New Zealand**  
Telephone  
0011 64 9273 1457

**Technical  
help line**  
1300 652 242

f /InnovaBuildingSystems  
@innovabuildingsystems  
/Innova Building Systems



innovafibreceiment.com.au

## EXTERIOR PRODUCTS AND APPLICATIONS

**DURACOM™** / A compressed fibre cement wall cladding system.

**DURAFLOOR™** / The ultimate flooring product that can be used in both interior and exterior applications.

**DURAGRID™ RESIDENTIAL & DURAGRID™ LIGHT COMMERCIAL /**  
A lightweight wall cladding system giving a modern and durable finish.

**DURAGROOVE™** / A vertically grooved exterior wall cladding system.

**DURASCAPE™** / A lightweight exterior wall cladding system with a subtle vertical shadow line.

**MONTAGE™** / A versatile pre-finished wall cladding system that can be used internally and externally.

**NULINE™ PLUS** / A weatherboard style cladding system.

**STONESHEET™** / Purpose designed substrate for stone tile facade.

**STRATUM™** / A range of plank products, each of which can be used as stand-alone products or used together to create a striking exterior cladding solution.

**DURASHEET™** / Ideal for the cladding of gables and lining of eaves. Can also be used on commercial soffits and cladding on non-impact areas.

**DURAPLANK™** / Available in Smooth, Woodgrain and Rusticated finishes, Duraplank™ is ideal for exterior cladding of upper storey conversions or ground level extensions.

**DURATEX™** / A base sheet used for textured coatings on exterior wall applications.

**DURALINER™ PLUS** / An exterior lining board that is the perfect substrate for tiles and is ideal for wet areas.

**COMPRESSED** / Used as a domestic, commercial sheet for wet areas, flooring, partitions, exterior decking, fascia and wall cladding.

**DURALUX™ PLUS** / Suitable for exterior applications where it will be sheltered from direct weather.

## INTERIOR PRODUCTS AND APPLICATIONS

**INTERGROOVE™** / Internal grooved wall lining.

**DURALUX™ PLUS** / An interior lining board suitable for ceilings and soffits.

**DURALINER™ PLUS** / An interior lining board, this is the perfect substrate for tiles and is ideal for wet areas.