

Installation Guide

Silhouette *by* **easy**craft



Australian Made

All our raw materials are produced by Australian manufacturers, our processing and painting is conducted locally. Easycraft has a national sales & distribution network to ensure that our products can be provided to any renovation, extension, residential or commercial construction site throughout Australia and New Zealand.



Quality

Easycraft panels provide the natural feel of timber without the defects, imperfections, knots and grain inconsistencies.

Easycraft panels are manufactured with a consistent density, thickness, width and length, and are suitable for use with fixing nails and countersunk screws. The panels can be loaded with significantly more weight than plasterboard.



Tough and Impact Resistant

Easycraft panels are 300% more impact resistant than standard plasterboard and 50% better than impact resistant plasterboard which makes Easycraft panels an ideal choice for corridors, foyers, high traffic areas of Education, Retail, Office and Aged Care & Health Care facilities. Refer Impact Test - Easycraft verses Plasterboard video on website. Out performs by up to 3 times.



Ease of Installation

Easycraft's easyjoin system provides a means to join one board to the next easily and seamlessly. The easyjoin system allows you to install your selected profile with no sign of interruption. Easycraft panels are easy to install, so much so that we have significant popularity among DIY home improvers.

Within commercial projects, it can be installed by one of the following contractors; Carpenter, Plastering Contractor or Joinery Contractor.

accreditations



Easycraft is committed to sourcing and using the best available environmentally sustainable timber for use in our wall & ceiling products and as such operates an AS 4707:2014 – Chain of Custody compliant management system for certified wood and forest products. Our core suppliers operate under the same Standard and have Chain of Custody Accreditation.

The Australian Standard is part of the Australian Forestry Certification Scheme which is endorsed by the Programme for the Endorsement of Forest Certification, in accordance with the PEFC International Standard – PEFC ST 2002:2013, Chain of Custody of Forest Based Products.



Building Code of Australia

Easycraft comply with Impact, Thermal, Acoustic & Fire requirements of the National Construction Code. Easycraft has formally tested their products and have available tests results.



Greenfirst

Global GreenTag certified products pass the world's toughest standards to protect you, and your family's health and safety, minimise your impact on our finite planet and put the power of selection back in your hands.



Wood Naturally

Easycraft is a proud promoter of the benefits of using wood based products, not only from an environmental perspective but also for the use, look, feel and additional hard wearing benefits.

contents

general product	2
installation essentials	3
tools & equipment	4
fixing to existing wall	5
direct fixing to brick & block walls	6
finishing options	7
alternative suggestions	7
finishing options	8
backfilling profile	8
wall to floor finishing options	8
finishing options	9
ceiling finishing options	10
ceiling finishing options	11
paint finish	11
fireplace installation	12
material references	12
limitations	13
manufacturers warranty	13
continuous improvement	13

contact us

If you require any further support for your Project or Specification, please contact Easycraft National Office, to be transferred to your Regional Sales Manager.

National Office & Manufacturing

140 North Road Wynnum West QLD 4178

Postal Address:

PO. Box 3496
Tingalpa DC QLD 4173

Phone:

All states please call: 07 3906 7200

Email:

marketing@easycraft.com.au

general product

Information

The following installation instructions and guides are in addition to local and state regulations and the requirements of the National Construction Code (NCC).

All diagrams in this installation guide are for demonstration purposes only.

Diagrams may omit some components for clarity.

Deviation from standard applications and requirements detailed in this installation Manual or supplementary

Easycraft construction details may void the manufacturer's product warranty.

Storage

The following recommendations should be applied to maintain Easycraft panels in good order and condition. The storage area should be protected from the sun, rain and wind.

Product should be stored flat, undercover and on timber bearers spaced at maximum 450mm centres.

Never store material outdoors or in an open area (verandah) or areas with newly poured concrete or in rooms that have been recently plastered.

Panel dimensions & joining

Please note, presented board & profile dimensions are nominal sizes and are subject to manufacturing variance.

Please check all panels on deliver to pre-plan installation based on sizing received.

When end-joining wall and ceiling panels profiles may not align exactly, so we recommend a moulding be placed over the join to minimise any variance.

Pre-conditioning

Pre-conditioning MDF panels is recommended so they attain an equilibrium moisture content (EMC) before fixing, so as to reduce the likelihood of bowing or shrinkage after they have been fixed.

Some boards may achieve an EMC simply by being stored for some time in the location where they are to be used without any positive conditioning.

We recommend product should be delivered to site minimum 48 hours prior to installation and stored in the environment of where it is to be installed to allow to acclimatise.

Cutting & working

Easycraft products are easy to cut and shape with a normal hand or power saw. The normal health and safety precautions should be taken when working with wood panel products. Machining equipment should be fitted with dust collection devices and used in well ventilated areas.

Follow good hygienic and housekeeping practices. Wood dust can be vacuumed, shovelled or swept to avoid accumulation. If dust levels exceed Safe Work Australia Standards the wearing of a dust mask (AS 1715 and AS 1716) and safety glasses (AS 1337) is recommended.

Storage and work areas should be adequately ventilated.

Base material

As with solid wood, MDF is a hygroscopic material (meaning it readily takes up and retains moisture), thus its moisture content depends on the relative humidity and air temperature in the surrounding environment. As the moisture content of MDF changes, it is subject to dimensional changes.

There are many variables which can ultimately affect the performance of timber, including the surrounding environment, quality of installation and quality of framing.

But managing changes in the environment humidity levels and moisture content plays a very important role in achieving the best results from the product.

In environments that can experience large changes in air temperature and humidity you may experience movement in the panels, either expansion or shrinkage.

Maintenance

The extent and nature of maintenance will depend on the environment and exposure of the installed panels. Easycraft products may be periodically cleaned with a damp cloth. Do not use high pressure washers, abrasive materials or cleaning products as this can cause coating damage and water ingress into the wall cavity.

Safety

Easycraft products are manufactured from wood products. Accordingly, machine tools should be fitted with dust extractors and operators should wear a dust mask and eye protection.

Further information is contained in the respective product Material safety Data Sheets (MSDS) available on our website.

GP General Purpose Interior

- Product should be delivered to site a minimum 48 hours prior to installation and stored in the environment of where it is to be installed to allow it to acclimatise.
- The framing must be straight and true.
- For Wall & Ceiling applications we recommend 450mm centres for framing.
- Fixings should be positioned no closer than 25mm to a corner and no closer than 15mm to the edge. This positioning will prevent splintering and breakout.
- A 10mm gap must be left at the floor if the wall lining is being installed only part way up the wall.
- A 5mm gap must be left at the top and bottom of the sheet if the wall lining is being installed from floor to ceiling.
- A 0.5mm expansion gap should be allowed at each join. Do not 'Hard Knock' the panels together.
- For each metre width of wall or ceiling, allow approx. 1.0mm for an expansion gap at the outer perimeters of your wall or ceiling. (e.g. 6m wall x 1.0mm = 6mm therefore leave a 3mm gap at each outer edge of wall or ceiling)
- Decide how you wish to finish off internal and external corners before you install the first sheet.
- We recommend for horizontal and ceiling applications that you DO NOT END BUTT sheets due to the potential for movement.

tools & equipment

Tools and Equipment

- Tape Measure
- Hand Saw or Power Saw
- Hammer / Nail Gun or Screw Gun
- Pencil
- Spirit Level
- String Line
- Caulking Cartridge Gun or Spatula
- P1 or P2 Dust Mask
- Safety Glasses (complying with AS1337)

Cutting:

Easycraft Wall Linings can be easily cut with a Power Saw or Hand Saw. When using a Power Saw, cut the board with the face side down. When using a Hand Saw, cut the board with the face side up.

Fixing:

If fixing with power tools ensure the driving pressure is only sufficient to drive the head marginally below the surface. If the driving pressure is too high and the nail is driven in too far, splitting of the board could occur and tool marks will show.

Please refer to our website, Help Centre for more detailed product and installation information.

Consumables

The following is a list of products that are suggested will perform in typical product applications.

- Use recommended Nails & Screws. Nails and Screws are to be long enough to penetrate the studs at least 25-30mm.
- A flexible construction adhesive is to be used to glue the sheets to the frame/Studs and noggins.
- The adhesive selected should allow for movement to take place.
- PVA adhesive is for gluing corners together and supporting the fixing of mouldings in place.
- **Nails**
Must be long enough to penetrate the studs at least 25-30mm.

Fixing wall linings:

- Hammer – use 2mm x 40mm anti-rust bullet head nail
- Nail Gun – use Paslode ND Brads 14ga x 45mm, 50mm & 60mm

Fixing ceiling linings:

- Nail Gun – use Paslode Duo-Fast C2.5 x 45 Ring Shank

- **Screws**

Fixing into timber frame:

ICCONS: Needle point CSK head part No. TP796)

- 8 -15 x 20 or 30mm ICCONS: Collated
- Needle point CSK head collated (IC Find # 796C or 798C)
- 8 -15 x 20 or 30mm

Fixing into steel frame:

ICCONS: Self-Drilling CSK head Self embed head (part No. TP326)

- 8 -18 x 20 or 30mm ICCONS: Collated
- Self-Drilling CSK head Self embed head collated (IC Find # 344C or 346C)
- 8 -15 x 20 or 30mm

- **Glues**

A flexible construction adhesive or stud adhesive should be used for fixing the sheets to the studs and noggins.

- **Sealants/ Gap Filler**

For the best result, a flexible (25% movement capability) paintable sealant must be used when fixing skirtings, cornices and timber mouldings to Easycraft Products. Easycraft recommends FulaSeal 720 and SikaflexPro+.

- **Miscellaneous**

- Spacers – use off cuts of the 9mm MDF or 10mm timber pieces.
- PVA adhesive for gluing corners together and mouldings in place.
- Best to use a Timber based filler to fill nail or screw holes.

fixing to existing wall

Step 1 - Preparing the Frame:

1. Studs must be spaced at no more than 600mm centres.
2. Check that frames are straight and true. Fix any irregularities.
3. Refer to the Drawings below for frame layout.

Step 2 - Installing the Sheets

1. Start from one corner of the room.
2. When installing EasyCraft sheets over existing wall lining apply generous dollops of flexible construction adhesive at 450mm intervals, on each stud and each noggin behind the first panel. Follow the adhesive manufacturer's recommendations for how much to use.
3. Place a 9mm or 10mm piece of timber or off cut of MDF under the bottom edge of the sheet, to raise it off the floor. You must allow a 9mm or 10mm gap at the bottom and/or top of all sheets.
4. Place the first sheet on the wall.
5. Check the sheet is plum (vertical) using a spirit level and fix the sheet using nails.
6. Space the nails approximately 500mm apart, fixing the sheet to the studs and noggins.
7. Remove the spacer from the bottom of the sheet.
8. Fix the other sheets using the same method outlined above, working along the wall from the first sheet.
9. Make sure you leave a 1.0mm to 1.5mm gap at each join to allow for expansion of the sheets.
10. When you get close to the corner or a doorway, measure the gap from the fixed sheet to the corner and cut the next sheet so that it fits the remaining space. Fix the sheet using the same method as described above.
11. When all the sheets are fixed fit skirtings and architraves and finish off internal and external corners.
12. For the best result, a flexible (25% movement capability) paintable sealant must be used when fixing skirtings, cornices and timber mouldings to Easycraft Products. Easycraft recommends FulaSeal 720 and SikaflexPro+.

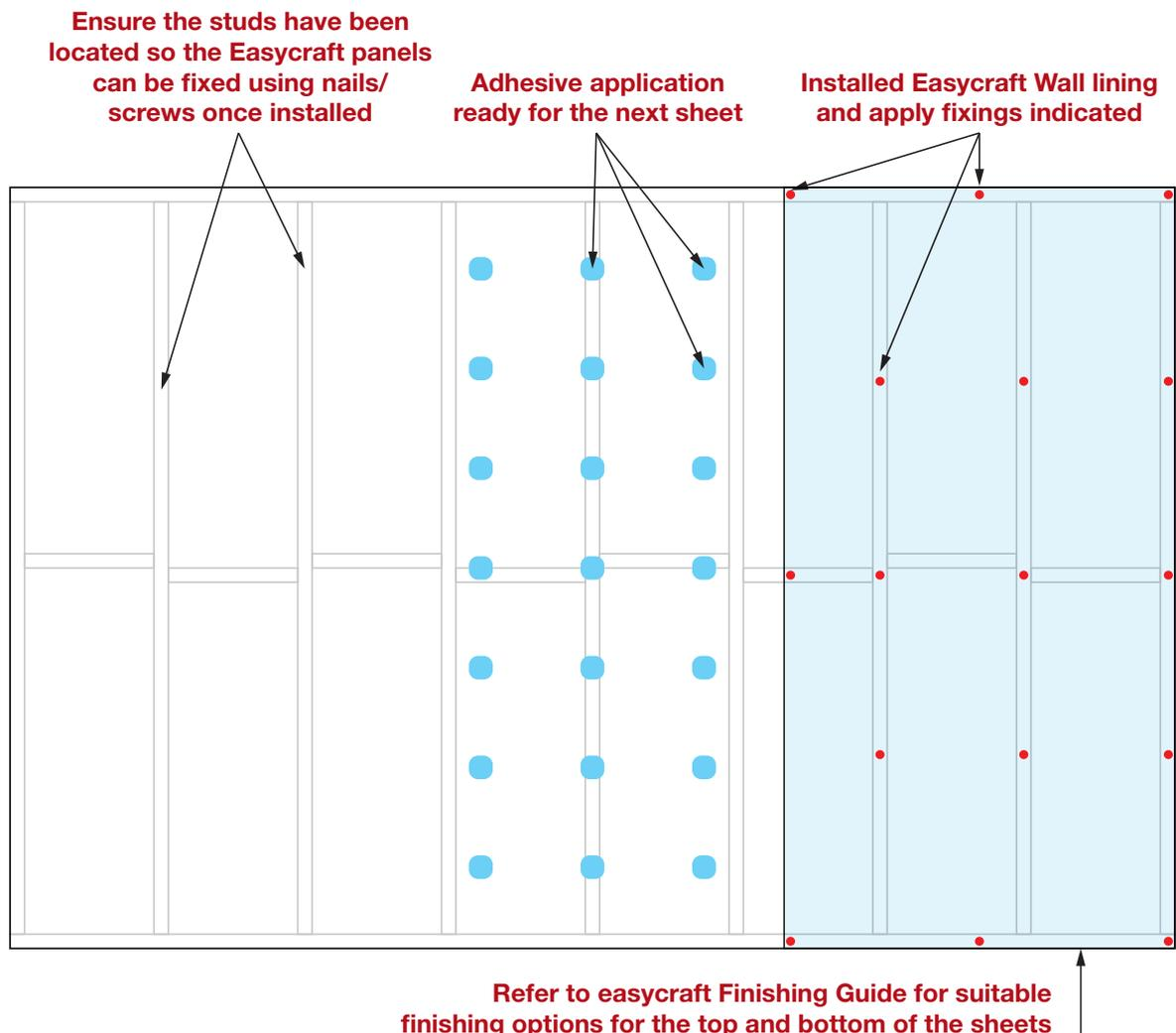

direct fixing to brick & block walls

Step 1 - Preparing the Wall:

1. Fix horizontal furring channels or battens to the masonry at 450mm centres
2. When sheets are part way up the wall place a noggin at the top to support the top edge.
3. Check that battens are straight and true. Fix any irregularities.
4. Refer to the Drawings for frame layout.

Step 2 - Installing the Sheets

1. Start from one corner of the room.
2. When installing Easycraft sheets over stud walls apply generous dollops of flexible construction adhesive on each batten behind each panel. Follow the adhesive manufacturer's recommendations for how much to use.
3. Place a 9mm or 10mm piece of timber or off cut of MDF under the bottom edge of the sheet, to raise it off the floor. You must allow a 9mm or 10mm gap at the bottom and top of all sheets.
4. Place the first sheet on the wall.
5. Check the sheet is plum (vertical) using a spirit level and fix the sheet using nails.
6. Space the nails approximately 500mm apart, fixing the sheet to the studs and noggins.
7. Remove the spacer from the bottom of the sheet
8. Fix the other sheets using the same method outlined above, working along the wall from the first sheet.
9. Make sure you leave a 1.0mm to 1.5mm gap at each join to allow for expansion of the sheets.
10. When you get close to the corner or a doorway, measure the gap from the fixed sheet to the corner and cut the next sheet so that it fits the remaining space. Fix the sheet using the same method as described above.
11. When all the sheets are fixed fit skirtings and architraves and finish off internal and external corners.
12. For the best result, a flexible (25% movement capability) paintable sealant must be used when fixing skirtings, cornices and timber mouldings to Easycraft Products. Easycraft recommends FulaSeal 720 and SikaflexPro+.

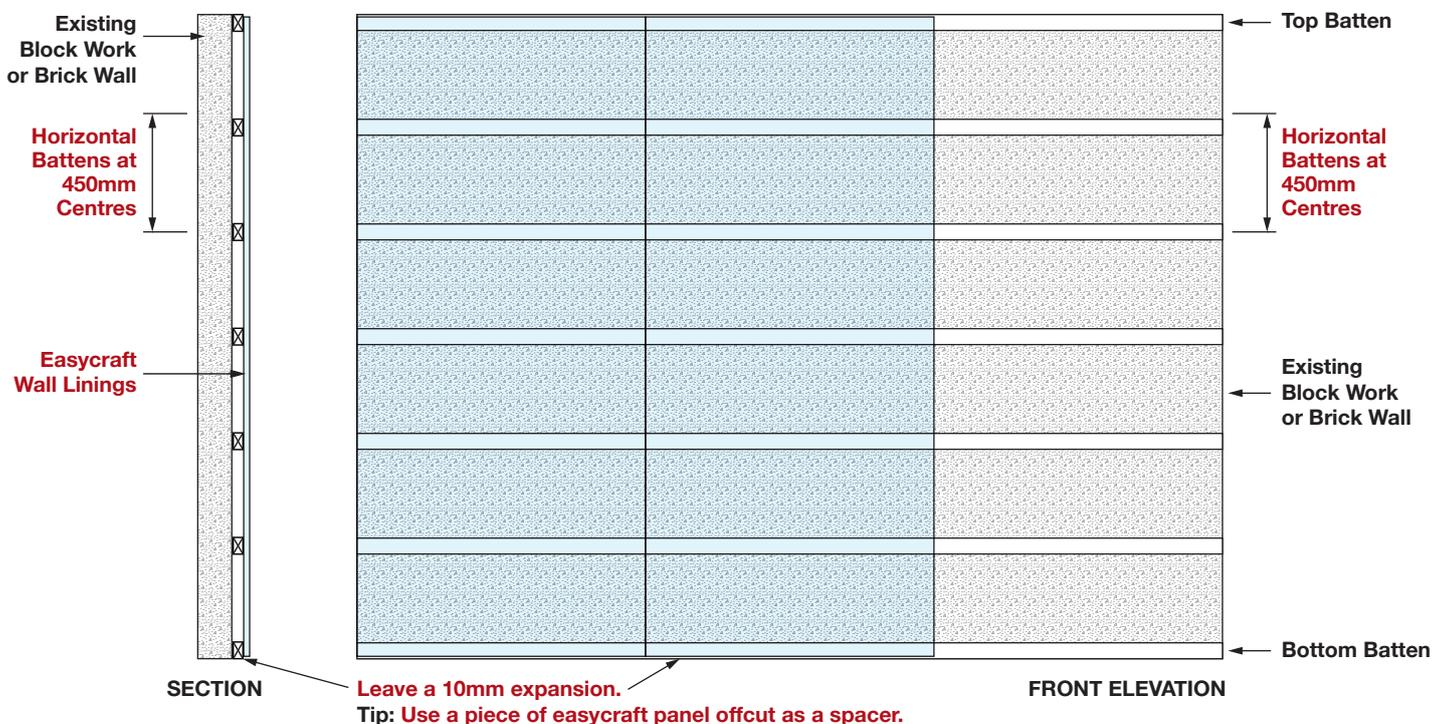

finishing options

Junction options - Mouldings

There are many options for finishing Easycraft panels in wall & ceilings applications, similar to plasterboard. We highlight below some examples of preferred finishing options for corners and end joining. These products are available direct from most timber and hardware retailers.

Visit Easycraft.com.au for videos on how to install Easycraft wall panels.

Internal and External Corner

Mitre

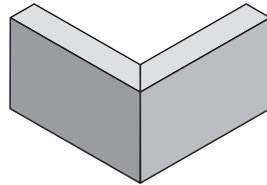

Internal and external corners using DAR Stops

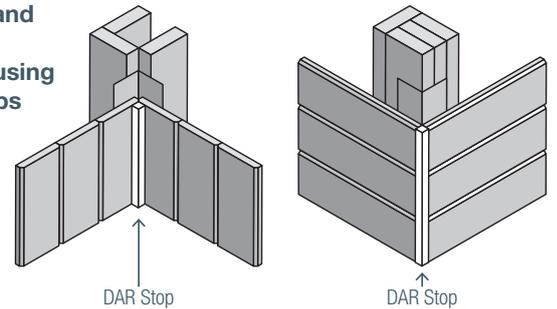

alternative suggestions

Aluminium Angles

Aluminium angles (or tile angles) can be found in any timber and hardware store/supplier and can be used to create borders and detail the ends of Easycraft's Silhouette range.

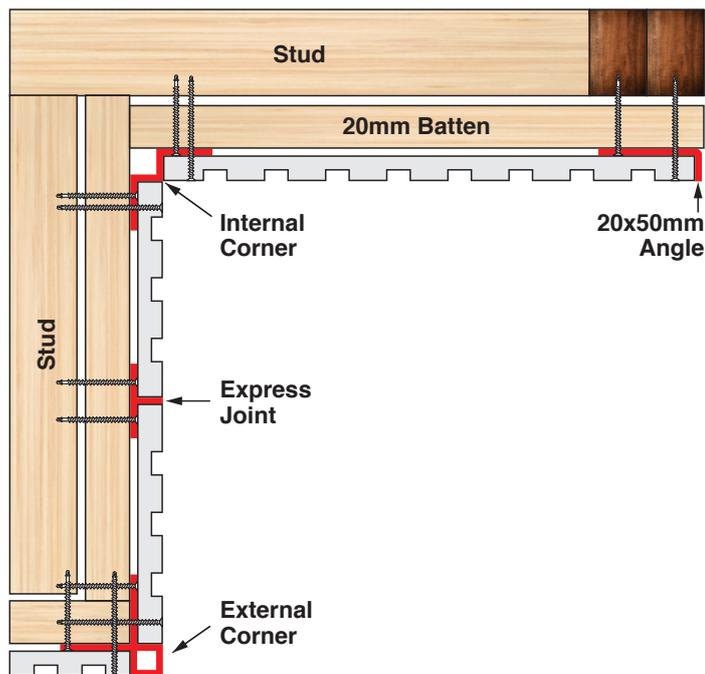

Timber Angles

Use DAR pieces of timber to create a boarder/frame to highlight Silhouette profiles.

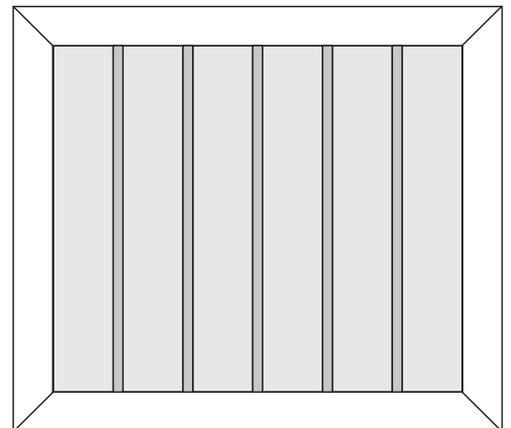

finishing options

Finishing the ends of the feature wall can be attained in many different ways;
Leave end of Silhouette exposed.

Timber Mould Finishing Ends

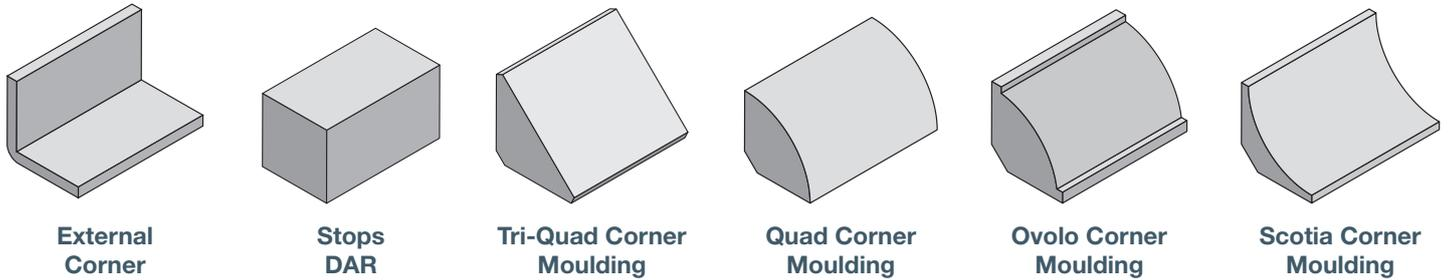

backfilling profile

Fast Curing Polyurethane Foam

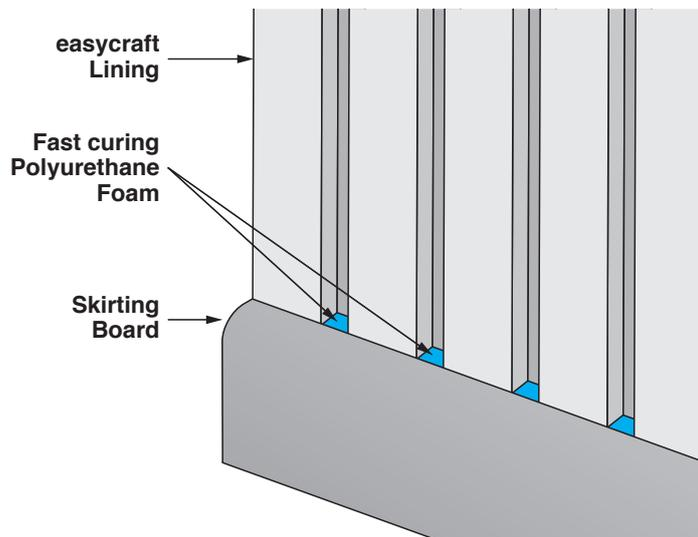

Use fast curing Polyurethane foam (Sika Boom AP) to fill gaps found between Easycraft Silhouette profile and rear side of your skirting board. (then cut, sand and paint)

wall to floor finishing options

Floor to Wall

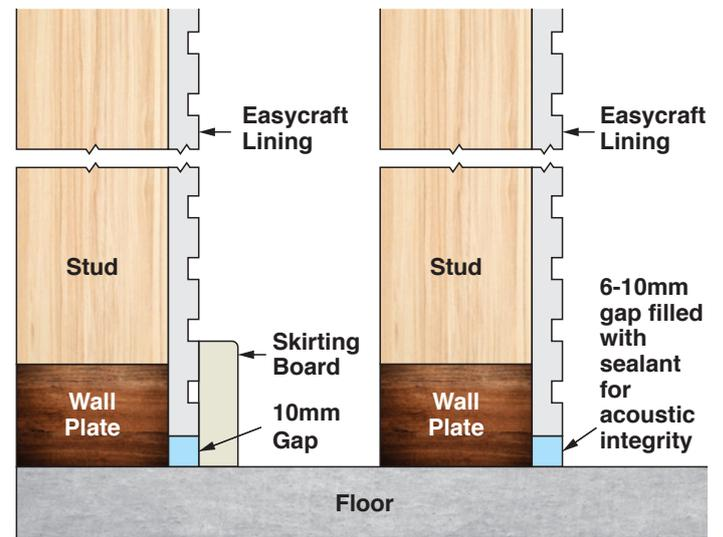

Shadowline Skirt Detail with Aluminium Angle

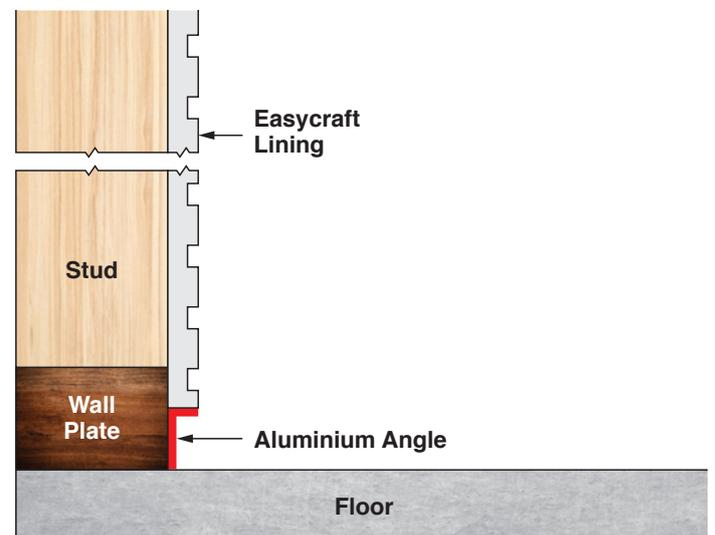

finishing options

6mm MDF Backing Board for Support

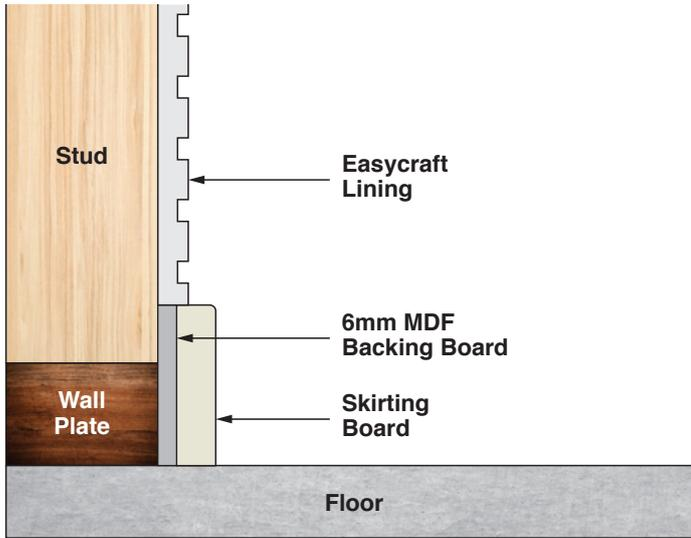

Shadowline Skirt Detail with 6mm MDF Backing

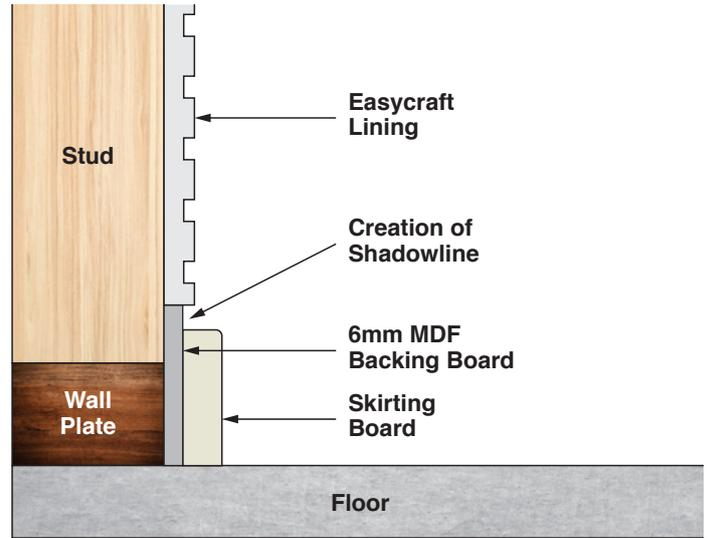

Applied over Existing Plasterboard

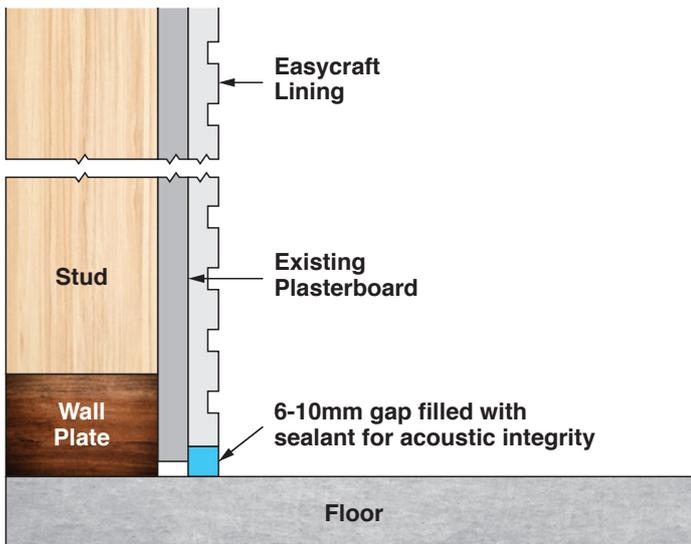

Applied over Existing Plasterboard with Skirting

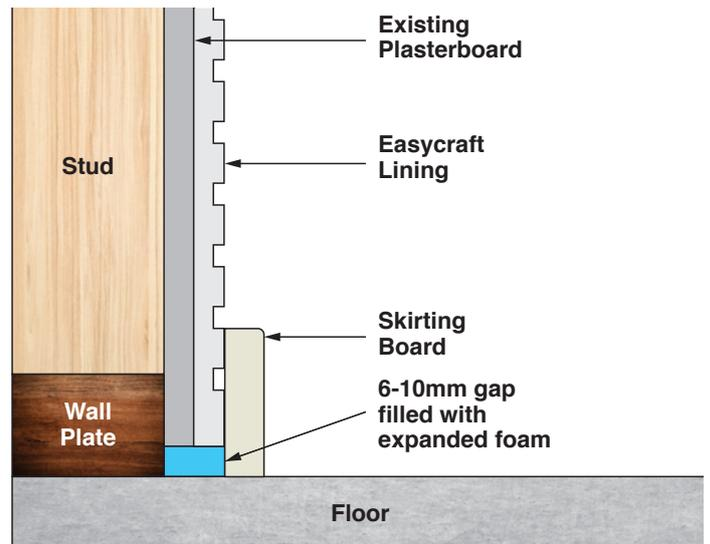

Over Existing Plasterboard with Shadowline

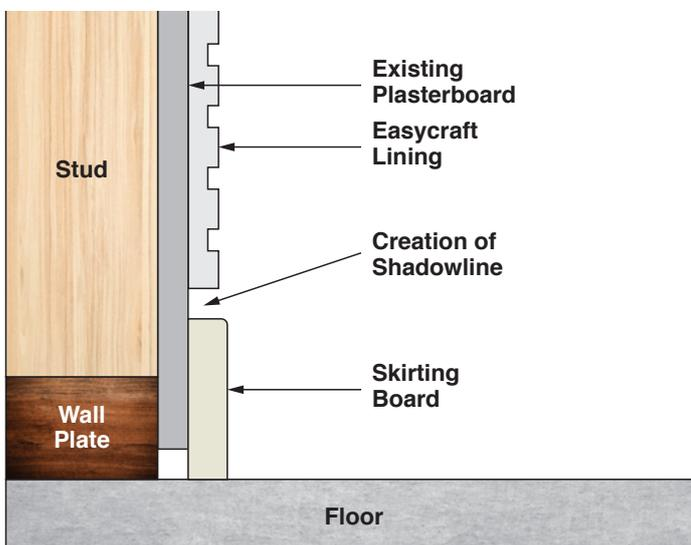

Dado wall height Timber DAR Section

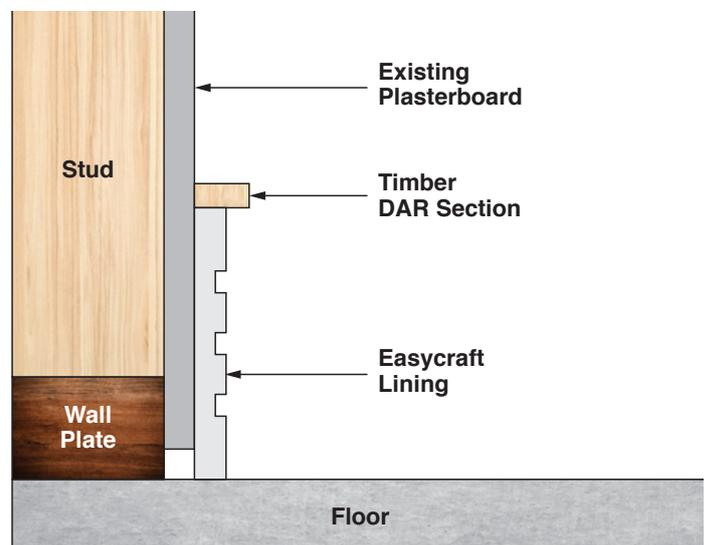

ceiling finishing options

Wall to Ceiling Options

Cornice can be Timber cornice/mould

- Plaster cornice
- Timber quad/bead, Quad, Scotia, Ovolo.

There are many plasterboard cornices and timber mouldings that can be used and are available through any timber and hardware and plasterboard supplier for your choice and selection, the above are suggestions, it is not limited to the images and profiles we have displayed, what we hope to achieve is to indicate there are many different ways to finish/detail Easycraft Panels.

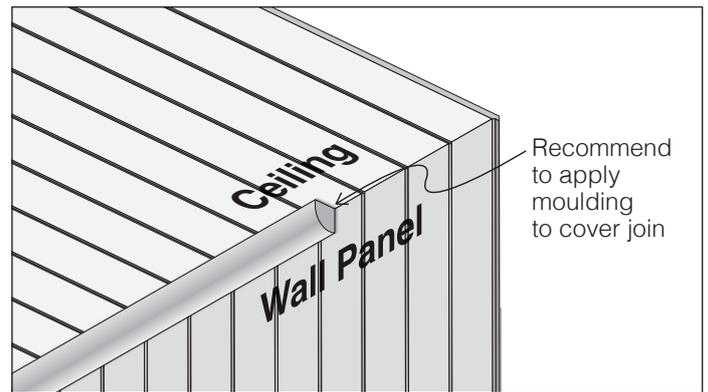

Plaster or Timber Cornice

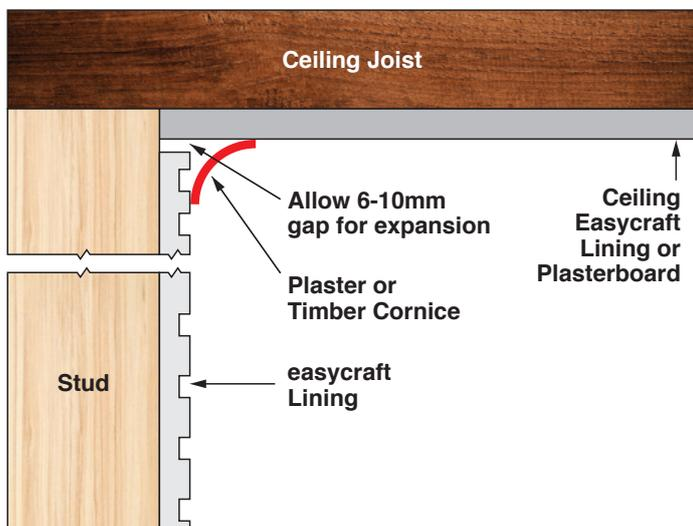

Direct Mount to Wall Stud

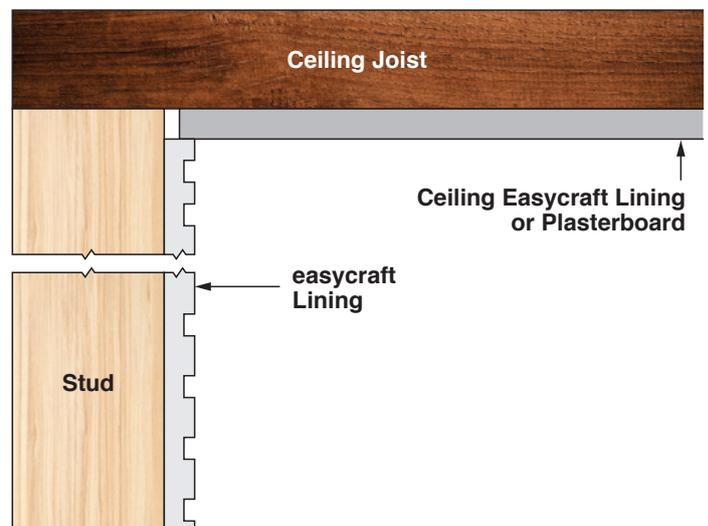

Tucked under Cornice over existing Plasterboard

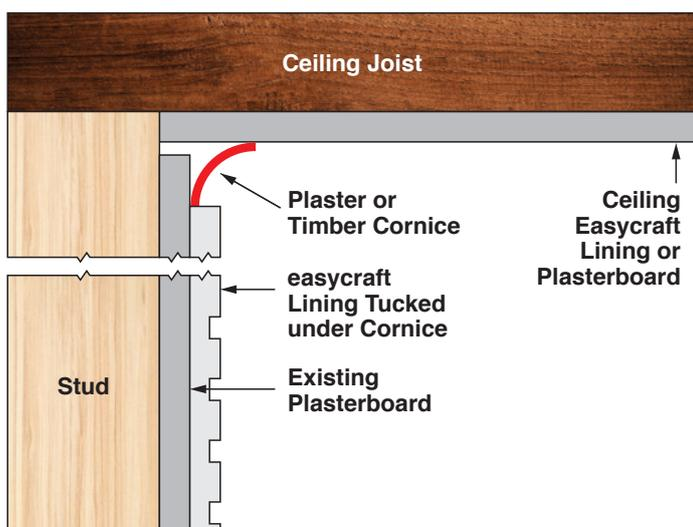

Direct Mount over existing Plasterboard

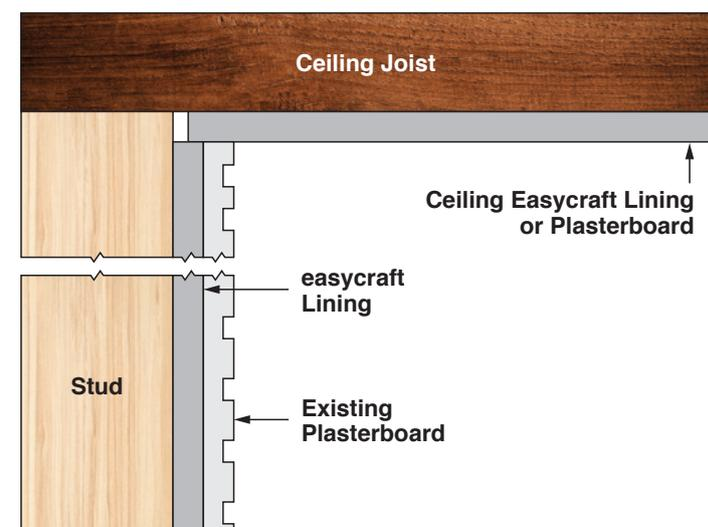

ceiling finishing options

paint finish

Shadowline Detail over existing Plasterboard

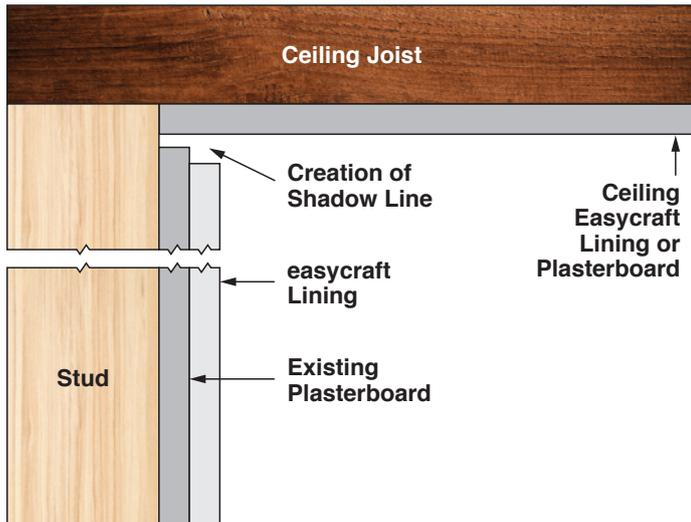

Butt End Alternatives

Generally, Ceilings, longer sheets are required (may also apply to walls where the product is being used horizontally).

Where sheets are required to join end to end (Easycraft recommend not end butting sheets, as movement of the building frame along with any environment change may mean the panels move marginally, which in turn cracks the join sealant (gap filler) and paint (leaving an unsightly jagged cracked caulk join).

We recommend looking at alternative ways of detailing sheets that are required to meet so the profile may continue, avoiding joining sheets butt end to butt end.

Square Dressed Cover Mould

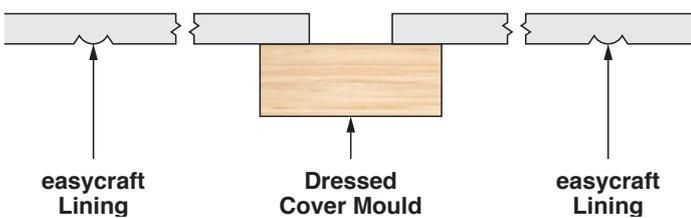

Shadow Line / Express Junction

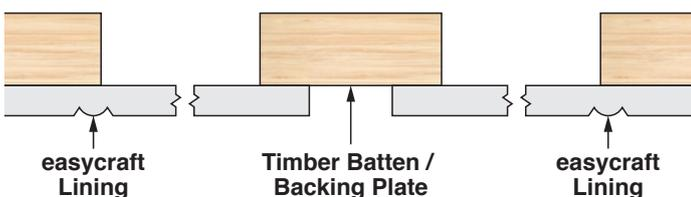

Pre-primed

Easycraft panels come pre-primed. Easycraft apply a commercial grade water-based primer that is cured during their manufacturing process by a combination of a UV light and an oven.

Preparation

Before painting is commenced it is important to ensure the surface of the Easycraft panel is properly prepared.

Fill all nail/screw holes and imperfections with a suitable water-based wood filler (such as Timbermate) and allow to dry.

Lightly sand all surfaces to be coated so as to obtain a smooth and even finish.

Dust off all sanded surfaces using a damp rag before painting commences.

Undercoat (you may apply another)

For conventional painting, the recommended type of undercoat or primer is a water-based acrylic type. Apply the coating in accordance with the manufacturer's instructions. When dry, all painted surfaces should be sanded smooth. It is recommended that the acrylic undercoat should not be watered down prior to use.

Final Coat

Ideally, an acrylic coating is selected as a top coat. Generally, paints that can be applied to plasterboard, work identically when applied to Easycraft panels.

Application of paints is typically by brush roller or spray. Brushes are used for small areas, cutting in the edges and profiled areas.

Rollers are typically used for large areas such as walls and ceilings.

Spraying should only be considered if you have the right equipment and expertise.

Paint Manufacturer's Warranty

Please note:

Paint Manufacturers' may not offer a warranty when applying their paint product onto another manufacturer's base primer.

We recommend you trial the application of the final paint coat onto our primer prior to installation and your final application.

Easycraft products can be ordered as raw, un-primed to allow you to apply both the base primer and final coat from the paint manufacturer of your choice.

fireplace installation

Recommendations:

- It is our recommendation to follow the manufacturer's installation recommendations in conjunction with Australian and New Zealand Standard 2918.
- Manufacturers require at times non-combustible materials. Unfortunately, Easycraft General Purpose and Wet Area Interior, Semi Exterior and Fire Rated materials are all combustible.
- Special consideration needs to be taken when installing Easycraft panels near a fireplace to avoid any potential safety hazards.
- If you are unable to find the required information you can refer to the installation diagram below which outlines a common exclusion zone for timber-based products. Please note that this is a guideline only as recommendations will differ between manufacturers.

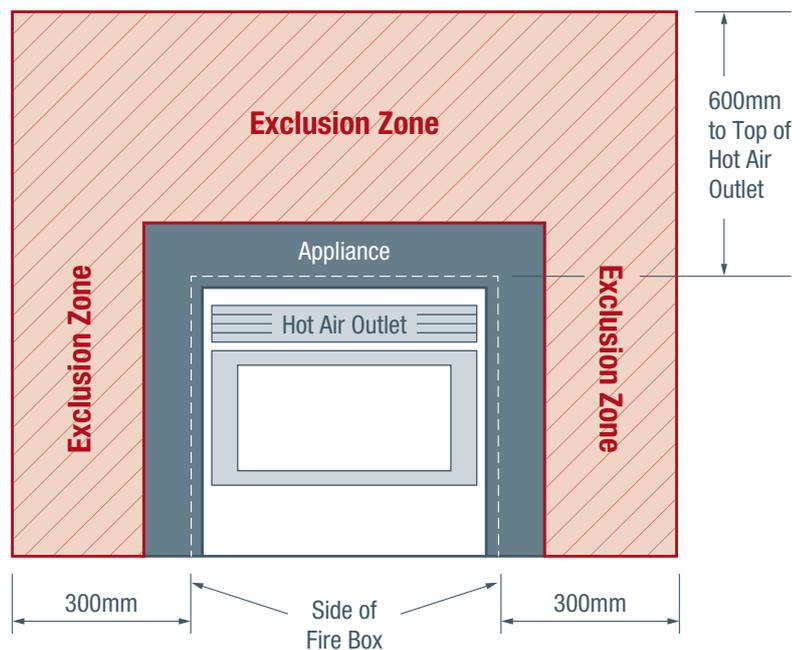

material references

The following documents can be viewed and downloaded at [Easycraft.com.au](https://www.easycraft.com.au)

[Installation Guide / Installation Videos](#)

[Product Data Sheets \(PDS\)](#)

[Safety Data Sheets \(SDS\)](#)

[Fire Test Results - AS 5637.1:2015 \(AS/NZS 3837\)](#)

[Chain Of Custody Certification](#)

[Global Green Tag Certification](#)

[Chain of Custody Product Schedule](#)

[Safe Work Method Statement](#)

[Health & Safety For Users](#)

[Material Handling & Storage](#)

[Bim \(Revit\), Cad - 3D Panel Drawings Provided](#)

limitations

The Information contained in this document is current as of September 2021 and is based on data available to Easycraft Pty Ltd at the time of going to print. All photographic images are intended to provide a general impression only and should not be relied upon as an accurate example of Easycraft products installed in accordance with this document or the BCA/NCC compliance documents.

This publication replaces all previous Easycraft installation information and literature relating to Easycraft Silhouette products. Easycraft Pty Ltd reserves the right to change the information contained in this document without prior notice. It is your responsibility to ensure that you have the most up to date information available, including at the time of applying for a building consent. Architects, Builders and Building Surveyors responsibility to ensure Easycraft products are being installed to meet with the National Construction Code.

Easycraft Pty Ltd has used all reasonable endeavours to ensure the accuracy and reliability of the information contained in this document. However to maximum extent permitted by law, Easycraft Pty Ltd assumes no responsibility or liability for any inaccuracies, omissions or errors in this information nor for any actions taken in reliance on this information.

manufacturers warranty

The company warrants (for 24 months) against defects due to defective factory workmanship and materials provided the installation procedures are strictly observed. The obligations assumed under this warranty are limited to repair or replacement or monetary compensation of any manufactured products and does not cover consequential losses such as accident, transport, removal, labour or other cost. All replaced products must be returned for inspection. This warranty applies only to the original purchaser and is not transferable. This warranty does not apply if the product has been improperly stored, installed, subjected to misuse, misplacement, abuse, neglect, repair or alteration (other than by the company).

Without limiting any other terms of this warranty, this warranty does not cover and Easycraft will not be liable for damage or defects which are not due to defective factory workmanship or materials, including but not limited to damage or defects caused by or arising from or in any way attributable to: (i) use of the Product in applications not recommended by Easycraft; (ii) the Product being subjected to abnormal treatment; (iii) impact, abrasion or mechanical action; (iv) surface marking, scratches or stains arising during or after the installation of the Product; (v) poor workmanship or installation, poor design or detailing, settlement or structural movement and/ or movement of materials to which the Product is attached, incorrect application design of the structure (used wrong material/wrong place... e.g. Fire Rated used for fireplace surrounds, General Purpose used in Wet Area); (vi) acts of God including but not limited to earthquakes, fire, cyclones, floods or other severe weather conditions or unusual climatic conditions; (vii) efflorescence, normal wear and tear, growth of mould, mildew, fungi, bacteria, or any organism on any Product surfaces or Product (whether on the exposed or unexposed surfaces); (viii) contact with chemicals such as solvents, detergents and pollutants, or exposure to a harsh chemical environment or an excessively salty environment; (ix) use of adhesive tapes, sealants or mastics on the Product, or recoating of the surface of the Product outside of the recommended maintenance guidelines in the relevant Easycraft literature; or (x) failure of third party coating systems, including but not limited to sealers and paints.

The Product is subject to natural variation in finish as part of the manufacturing process. Easycraft is not liable for any variation in the look of the Product including but not limited to: any variation in colour or surface pattern; any variation between different batches of the Product; or any variation against any sample material provided.

The company shall not be liable for any defects in goods not manufactured by it but the company will endeavour to pass on to purchaser the benefit of any claim made by the company and accepted by the manufacturer for such goods under the warranty given by that manufacturer.

This guarantee is additional to any condition or warranty applying by virtue of the Competition and Consumer Regulations January 2012 and to all other rights and remedies had by a consumer of goods and services in law.

continuous improvement

Easycraft has a policy of continuous product testing and improvement. For this reason we reserve the right to make any changes or modifications to the information contained in this document as we consider necessary and without notice. Errors and omissions excluded.

