

STRUCTAflor

Structural Flooring





R-flor YELLOWtongue



Fixing pattern



STRUCTAflor H2 BLUEtongue & GP YELLOWtongue



STRUCTAflor GP YELLOWtongue

Introduction 4

Our Leading Brands
40 Years of Trust

Key Points

STRUCTAflor GP, STRUCTAflor H2 & R-flor 6

STRUCTAflor GP
STRUCTAflor H2
R-flor

Product Details
The Facts That Matter

Termite Risk Management 8

Termite Hazard Map
Resistance to Termites

Application & Construction Requirements 9

Ground Clearance
Construction Requirements

Ventilation/Vapour Barriers
Framing

Product Installation 10

Installation Methods
Bushfire Areas
Expansion Joints
Installation Details
Standard Fixing – for tongue & groove panels

Platform Exposure
Double Layers
Adhesives
Fasteners

R-flor Radiant Barrier Structural Flooring 14

R-Values – Downwards or Upwards?
Energy Efficiency
Energy Efficiency Regulations Overview

Particleboard Flooring R-Values
Additional Insulation
Fixing to Timber & Steel Joists

Energy Efficiency 17

Further Information

Wet Area Installation 18

Wet Area Surfacing

Decorative & Surface Finishing 19

Concrete Surfacing
Surface Finishing
Quarry & Ceramic Tiles

Resilient Sheet & Tile
Clear or Tinted Finishes

Other Applications 20

Alternative Applications

Physical Properties 21

Health & Safety
Product Material & Properties
Particleboard Flooring Properties

Fire Hazard Properties
Thermal Insulation

FAQ 23

Fixing
Areas of Use

After Fixing

Leading Brands

STRUCTAflor General Purpose (GP) YELLOWtongue is still by far the number one product in its class, YELLOWtongue's proven reliability and durability makes it the clear choice in flooring for more builders.

STRUCTAflor GP, STRUCTAflor H2 and R-flor are available in a range of products and easily recognised by their well known YELLOWtongue, REDtongue and BLUEtongue particleboard tongue joining strips.



In the building business, your reputation's only as good as the materials you use. That's why when it comes to structural particleboard flooring, you need a product you can trust and a partner you can rely on to keep pace with ever-changing lifestyle and construction requirements.

Our Leading Brands

STRUCTAflor General Purpose, STRUCTAflor H2 Termite Protected and R-flor Radiant Barrier Flooring offer a practical, flexible and cost effective choice when building your new home or extension. With an extensive range of options, they are ideal for: sub-floors, suspended floors in multi-storey construction, additions and extensions and commercial flooring; as well as a host of building applications.

With over 40 years of reliable performance, STRUCTAflor is still the leading product in its class. The proven performance of STRUCTAflor GP, STRUCTAflor H2 and R-flor makes them the clear choice in flooring for builders. And just as they were the first product of their kind on the market, they continue to lead the way in innovation and development of flooring solutions.

40 Years of Trust

After 40 years of dedicated production and innovation, STRUCTAflor GP and STRUCTAflor H2 remain the number one choice for the majority of Australian builders.

The following information provides a guide to the applications, properties and features of the full product range. It also details the appropriate installation systems for STRUCTAflor GP and STRUCTAflor H2.

Note:
Particleboard flooring is not to be used in weather exposed end applications or with under-carpet heating.



Key Points

Storage

STRUCTAflor is designed to withstand full weather exposure for up to five months. Because of this there is a tendency to leave packs unprotected on site before installation. Packs of STRUCTAflor must be protected from the weather until it is installed as moisture penetration of the product before installation may lead to gaps occurring at the flooring joints when the product dries out.

When storing outside, ensure packs are kept clear off the ground. Cover with waterproof sheeting laid on timber battens so that air circulates freely between the waterproof cover and the product.

Exposure

The product may be exposed to the weather for up to five months. However, it is always advisable to enclose the building as soon as possible after laying the floor. During the exposure, prevailing weather conditions can influence the surface condition of the board and may cause minor swelling following the enclosure of the building, this can be removed by sanding. The depth of material removed shall not exceed the following:

- 1mm – Over the general panel area
- 2mm – Within 50mm of any supported edge

Remove any water that ponds on the platform by sweeping or by drilling holes (no larger than 8mm in diameter and no closer than 1 meter apart).

Installation

Adhesives

The Australian Standard allows for either flexible or rigid construction adhesive to be used.

Fasteners

Screw fixing is the preferred method, however the Australian Standard allows for either screw or nail fixing into timber joists.

Designed to provide a total flooring concept, STRUCTAflor GP, STRUCTAflor H2 and R-flor are particularly suited to platform construction where the floor is laid prior to the erection of walls. They are made from precision milled wood flakes and bonded with moisture resistant synthetic resin. For additional protection during construction and exposure to weather, the upper surface is resin enriched and all edges of the tongue and grooved sheets are coated.

Factory grooved long edges are fitted one side with a distinctive, colour-coded rigid Polypropylene (PP) tongue to ensure a neat, tight fit for adjoining panels.

STRUCTAflor GP, STRUCTAflor H2 and R-flor are available in YELLOWtongue, REDtongue and BLUEtongue tongue colours. The tongue and grooved sheets are supplied in easy-to-handle 600mm or 800mm widths. This comprehensive product range allows the selection of flooring to meet specific needs. The products provide total compatibility and cover large areas fast.

YELLOWtongue – 19mm

An interior all-purpose flooring for use primarily in residential buildings and designed for both platform and fitted flooring construction methods. YELLOWtongue will support imposed loads for general areas in houses as required by AS/NZS 1170.1-2002. Permanent, imposed and other actions. At 19mm thick, the maximum joist centres for YELLOWtongue STRUCTAflor GP, STRUCTAflor H2, and R-flor is 450mm for general residential applications.

REDtongue – 22mm

REDtongue is a thicker all-purpose flooring for larger joist spacings or higher load capacity. At 22mm thick the maximum joist centres for REDtongue STRUCTAflor GP, STRUCTAflor H2, and R-flor is 600mm for general residential applications.

BLUEtongue – 25mm Heavy Duty

A 25mm thick particleboard flooring specifically for residential, commercial, industrial and institutional buildings. Subject to span and deflection limits, STRUCTAflor GP may be used over various floor joist spacings to support a wide range of concentrated and uniformly distributed loads.

Floor loads will depend on the nature of occupancy and floor use. Refer AS/NZS 1170.1. When used over floor joists at 450mm maximum centres, 25mm thick BLUEtongue will support live loads in excess of 10kPa uniformly distributed and 4.0kN concentrated.

	YELLOWtongue	19mm
	REDtongue	22mm
	BLUEtongue	25mm

STRUCTAflor GP
General Purpose Structural Flooring

STRUCTAflor General Purpose

General Purpose particleboard sheet flooring, manufactured in Australia to comply with the requirements for Particleboard Flooring, Class 1, in AS/NZS 1860.1, Particleboard flooring.

With its unique hard-wearing resin enriched surface, yellow edge coating on the PP tongued variants – it is the quality flooring for every Australian Home.

STRUCTAflor GP is available in YELLOWtongue, REDtongue, BLUEtongue and Square Edge variants.

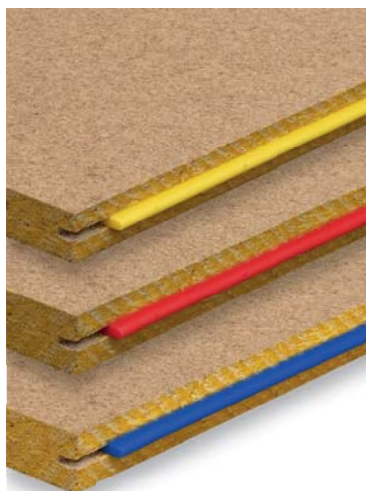

STRUCTAflor H2
H2 Treated Structural Flooring

STRUCTAflor H2 Treated

A termite protected sheet flooring that provides added protection against termite attack. It should be used in conjunction with the normal precautions against termite attack which include adequate sub-floor ventilation and the provision of physical or chemical barriers to AS 3660.1 Termite Management – New Building Work.

STRUCTAflor GP, STRUCTAflor H2 is also safe to use and environmentally friendly and is easily identified by its blue edge colour.

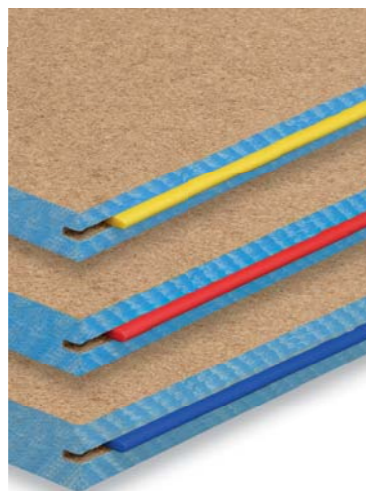

R-flor
Radiant Barrier Structural Flooring

R-flor Radiant Barrier Flooring

R-flor radiant barrier flooring is a particleboard flooring with a foil laminated on the underside of the flooring board. It has a low emittance (high reflectance) metallised foil surface which significantly reduces the radiative heat transfer across a suspended timber floor. The subfloor air space delivers an improvement in the "Total R-Value" of the flooring system.

R-flor incorporates a termicide for added protection against termites and is easily identified by its blue edge coat.

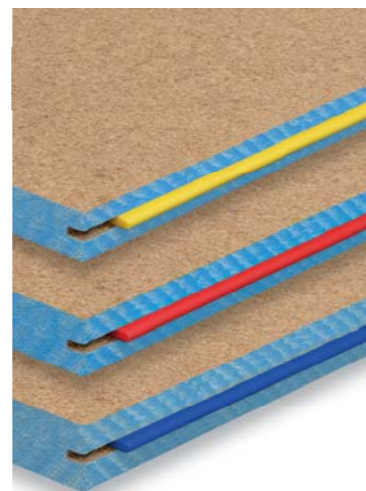

Thickness	Joist Spacing (max)		STRUCTAflor GP		STRUCTAflor H2		R-flor
			3600 x 800mm	3600 x 600mm	3600 x 800mm	3600 x 600mm	3600 x 800mm
19mm	450mm	YELLOWtongue	✓	✓	✓	na	✓
22mm	600mm	REDtongue	✓	✓	✓	na	✓
25mm	600mm	BLUEtongue	na	✓	na	✓	✓

Product Details

Thickness: 19mm, 22mm and 25mm nominal.

Surface Qualities: Upper surface is unsanded to retain a resin film, retard moisture and provide a working surface during installation.

Edge Coating: Factory applied to all edges of tongue and grooved sheets to reduce moisture ingress.

- Yellow coating for STRUCTAflor GP YELLOWtongue, REDtongue and BLUEtongue Heavy Duty
- Light blue coating for STRUCTAflor H2 YELLOWtongue, REDtongue and BLUEtongue Heavy Duty
- Blue coating for R-flor YELLOWtongue, REDtongue and BLUEtongue Heavy Duty

Edge Profiles: Tongue and grooved long edges with square cut ends.

Tongue System: Factory fitted, rigid PP tongues ensure a tight fit and precise alignment of unsupported edges.

Resin: Synthetic resins for high moisture resistance.

Identification: Stamps on the underside of boards indicate required joist spacings.

NOTE: AS 1860.2 Particleboard Flooring – Installation recommends that panels be factory sealed against water penetration. Where panels are not factory sealed, and where panels are cut to size on site, the edges should be sealed with adhesive used to bond the panels to the joists.

The Facts That Matter

- **Resin Enriched Surface**
 - Added weather protection during construction for up to 5 months
 - Hardwearing working surface during installation
- **Edge Coat**
 - Minimises moisture ingress
 - Easy product identification:
 - Yellow – STRUCTAflor GP
 - Light blue – STRUCTAflor H2
 - Blue – R-flor
- **Wax Impregnated throughout**
 - In-built moisture protection for cut sheets
- **Synthetic Resin System**
- **Meets or Exceeds AS/NZS 1860.1**
- **STRUCTAflor GP & STRUCTAflor H2 range:**
 - YELLOWtongue – 19mm Domestic Flooring – 450mm joist spacing
 - REDtongue – 22mm Domestic Flooring – 600mm joist spacing
 - BLUEtongue – 25mm Heavy Duty Commercial Flooring
- **800mm wide sheet**
 - 2.88m² coverage (per sheet)
- **600mm wide sheet**
 - YELLOWtongue sheet weighs < 30kg (approx)
- **Australian Plantation Pine**
 - Grown from managed and renewable
- **Built on 40 years of trust**

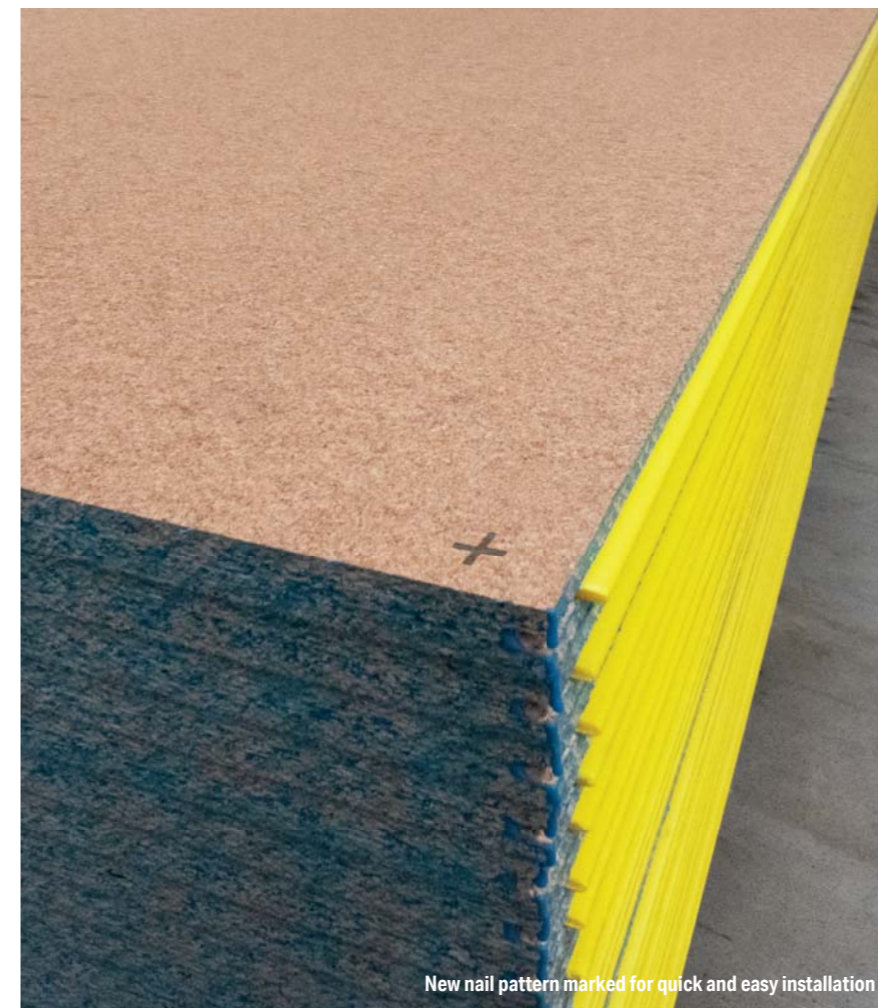

New nail pattern marked for quick and easy installation



Termite Hazard Map



Figure 7. AS 1860.2 Sanding Provision
STRUCTAflor H2 is resistant to termites both north and south of the Tropic of Capricorn. Dotted line represents the Tropic of Capricorn.

Resistance to Termites

Termites (also known as white ants), feed on any cellulose based material, such as timber. In areas defined as termite-prone (check with your local authority), physical barriers such as ant caps or chemical treatments need to be applied in accordance with AS 3660.1.

STRUCTAflor H2 and R-flor are resistant to both the subterranean termite (including *Mastoterms darwiniensis*) and the timber beetle.

STRUCTAflor H2 and R-flor termite resistant particleboard flooring conforms to H2 level treatment requirements as defined in AS 1604.2. Timber and wood based products treated to H2 level or higher are deemed to be termite resistant building materials under the Building Code of Australia and AS 3660.1.

Depending on individual state or local legislation, termite resistant structural timber and wood building components may be used in full or part to satisfy the Building Code requirements for protection of building against termites. However the householder is recommended to have this building regularly inspected for termite activity in accordance with AS 3660.2 by a qualified pest controller or building inspector.

STRUCTAflor H2 and R-flor flooring are protected, by a synthetic pyrethroid insecticide from the most common species of subterranean termites in Australia

including *Coptotermes* spp, *Schedorhinotermes*, *Nasutitermes* and *Mastoterms darwiniensis* and hence is suitable for use both south and north of the Tropic of Capricorn.

STRUCTAflor H2 and R-flor termite resistant particleboard flooring are protected from termite attack by incorporation of an Australian Pesticides and Veterinary Medicines Authority approved wood preservative in accordance with AS 1604.2 (and also approved by Forest NSW and the Queensland Department of Primary Industries), the Timber Marketing Act (NSW) 1977 (if applicable), the Timber Utilisation and Marketing Act (Qld) 1987 (if applicable) and is compliant with AS 3660.1.

STRUCTAflor H2 and R-flor particleboard flooring are regularly tested by an independent, accredited third party laboratory.

Two destructive termite species found in Australia



Coptotermes acinaciformis



Mastoterms darwiniensis

APPLICATION & CONSTRUCTION REQ.

Ground Clearance

The BCA (and AS 3660.1: Termite Management) requires a minimum ground clearance of 150mm to underside of bearer where termite inspection is not required. Where termite inspection is required, 400mm minimum height from ground surface is required. On sloping sites, 400mm clearance may be reduced to 150mm within 2m of external walls.

Where termite barriers are not installed or don't require inspection, a minimum 400mm ground clearance is advised as good practice.

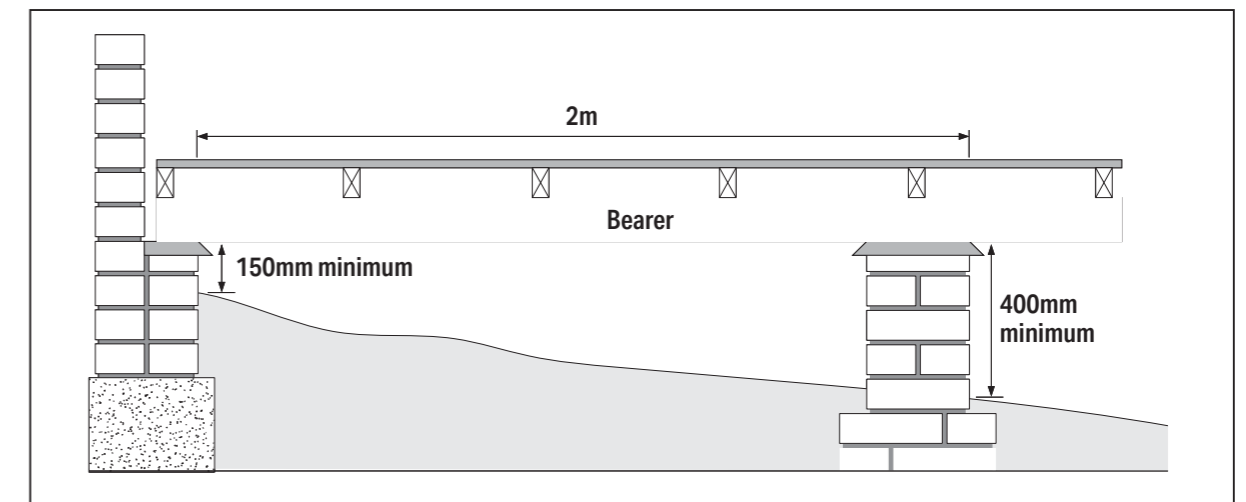

Construction Requirements

General

Particleboard flooring should be installed in accordance with government building regulations and AS 1860.2.

It may be used over conventional joists in single storey or two storey construction in accordance with AS 1684 Residential Timber Framed Construction. In commercial or domestic applications involving increased floor loadings, reference should be made to AS 1170 Structural design actions. The supporting frame should comply with the requirements of the Building Code of Australia and/or be certified by a professional engineer, as may be required by the building authority.

Wet Area Rooms

Particleboard flooring is accepted by building authorities for use beneath impervious floor surfacings in wet area rooms such as bathrooms, laundries and toilets. The waterproofing of the floor surface should comply with AS 3740, Waterproofing of Wet Areas in Residential Buildings.

We recommend that wet rooms (bathrooms, laundries and toilets flooring) be entirely waterproofed.

Ventilation/Vapour Barriers

Ventilators to external and internal subfloor walls should satisfy the requirements of the Building Code of Australia, be evenly spaced and allow a clear cross-flow of air beneath the floor. Particular attention should be given to the ventilation of corners.

Increased levels of ventilation are advised for subfloor spaces which are subjected to occasional dampness.

The particle flooring subfloor members should not be subjected to prolonged dampness. The moisture content of particleboard flooring should be maintained below 13% moisture content.

To assist drainage and ventilation, the ground should be graded to fall and weep holes provided in the external walls. In some circumstances 0.2mm (minimum) plastic sheet ground covers may be used to retard the rise of moisture vapour.

The underside of STRUCTAflor facing the ground must not be coated with sealant.

Framing

Particleboard flooring may be used over timber or metal floor joist systems. For best results with timber frames, deep floor joists (150mm or more) such as those used in upper story construction, should be seasoned and gauged.

Securely fix floor joists to bearers. The top surface of joists must be level to allow the flooring sheets to lie flat and level. Kiln dried or stabilised timbers are recommended for use. Green (unseasoned) timber (joists and bearers) may shrink unevenly as they dry which may lead to distortion of the particleboard flooring sheets as well as causing protrusion of nail heads after joists and bearers have stabilised in moisture.

Floor joist spacings must not exceed the span capacity of the particular particleboard flooring product. Refer to "Applications" or "Product Details".

Installation Methods

These instructions are taken from AS 1860.2 – Particleboard Flooring Installation, Engineered Wood Products Association of Australasia (EWPPAA) Particleboard Structural Flooring Design Manual, Building Code of Australia (BCA) and relevant timber framing and building standards.

Bushfire Areas

The method of determining the Bushfire Attack Level (BAL) for a site has been revised and now comprises six categories, namely BAL-LOW, BAL-12.5, BAL-19, BAL-29, BAL-40 and BAL-FZ. These categories are based on heat flux exposure thresholds.

The methods for determining the Bushfire Attack Level now include both a step-by-step procedure, including tables that list climate, slope of ground and vegetation variations in States and Territories and a detailed calculated procedure.

Please refer to AS 3959 “Construction of Building in Bushfire-Prone areas” and “Guide to building in bushfire affected areas”.

Particleboard flooring will expand and contract as sheets respond to changes in atmospheric moisture. Allowance for this movement must be made throughout the floor area by providing gaps and special joints as appropriate to accommodate sheet expansion.

Expansion Joints

For small areas, the gaps left between panels when laid by hand should accommodate normal hygroscopic movement. For large floor areas the hygroscopic movement of the particleboard flooring should be taken into account in the design. Refer to AS 1684.

The Building code of Australia references AS 1684 standard as the Acceptable Construction Manual for timber framed construction. AS 1684 stipulates the following provisions for expansion joints for all flooring material to be:

“For continuous floor widths over 6m, measured at right angles to flooring, intermediate expansion joints shall be provided in addition to the perimeter gaps. This joint shall be either a single 10mm wide gap (under a wall or across a hallway), or smaller gaps with closer spacing to give an equivalent space”

Installation Details

Particleboard flooring sheets are laid with their long side across floor joists and ends butted over a joist. Sheet end joints should be staggered (as illustrated in Figure 2) because any slight rounding of sheet corners may present a hole in the floor if four corners come together.

Select a starting point for laying and set a string line to ensure the first sheet is square with the joists. Position the first sheet with its tongued edge to the string line and note the printed information on the sheets regarding top surface.

Each sheet must be supported by at least three joists. If this is not possible (cutting in around the room perimeter) then nogging should be fixed under the edges of these smaller pieces.

Arrange sheets as in “Platform Installation” e.g.: T&G edges at right angles to floor joists.

Ensure floor joists and trimmers are installed at the room perimeter to support sheet edges and

ends. Provide 10mm clearance between edges and wall frames. Cover with skirting fixed through wall linings to the wall frame.

Stagger end joints (stretcher bond pattern) and locate centrally over joists).

Fitted Construction

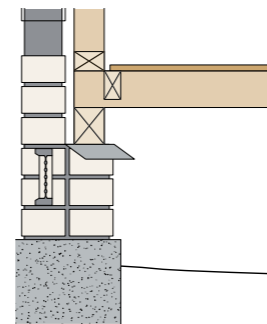

This applies to STRUCTAflor GP and STRUCTAflor H2 installation after the walls have been erected. Floor joists and trimmers must be installed so that all sheet edges at the room perimeter are supported.

Platform Construction

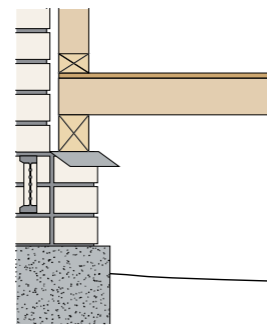

The product is particularly suited to platform construction. The method provides a working platform for wall and roof frame erection and contributes to time and cost savings.

In platform construction, sheet edges at the building perimeter are aligned with the outside edges of external wall frames. Wall plates are laid over product and fixed through the sheets to the joists.

Installation methods depend on the edge profile and the construction method – either “fitted” or “platform”.

Standard Fixing – for Tongue & Groove Panels

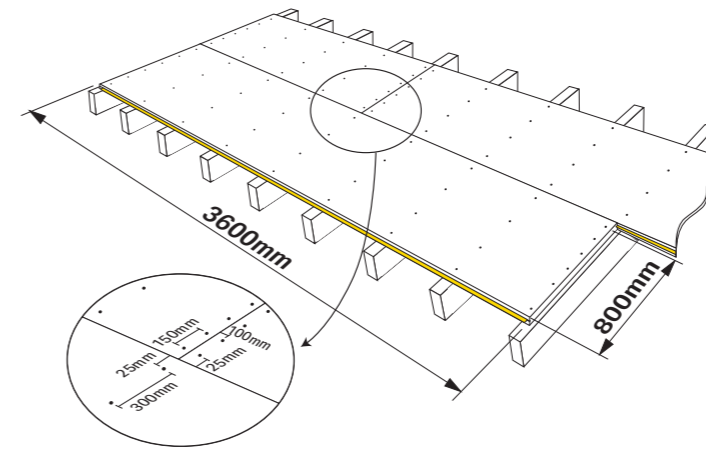

Figure 1. Fastener Spacing - 3600x800 sheets
250mm maximum centres – body of sheet
150mm maximum centres – sheet edges

25mm from T&G edges
10mm (minimum) from square edges (butt joint)

Platform Exposure

The product may be exposed to the weather for up to five months. However, it is always advisable to enclose the building as soon as possible after laying the floor. During exposure, prevailing weather conditions can influence the surface condition of the board and may cause minor swelling. Following the enclosure of the building, this can be removed by sanding – see Figure 2.

Remove any water that ponds on the platform by sweeping or by drilling holes (no larger than 8mm in diameter and no closer than 1 metre apart) in positions which will eventually be covered by wall plates, cupboards or skirting.

Excessive and differential drying of particleboard flooring sheets after it has been wet may result in cupping and shrinkage of the product which could, in extreme circumstances, cause pull-out or pull-through of nail heads. If this occurs, screwing the flooring sheet to the joists will be required to prevent the floor from movement and possible squeaking. In severe cases, shading may be required, or alternatively, light wetting of the flooring surface may be required to recondition sheets back to uniform moisture contents.

Do not apply plastic sheeting or surface sealants over the exposed platform as they will trap moisture and retard drying out. Furthermore, this can result in dimensional change.

The hygroscopic movement of the particleboard flooring (or any flooring) should be taken into account in the design.

General damage to the flooring surface can occur through various means. Avoid the build up of plaster, concrete, paint etc. on the floor and do not use the floor:

- For stacking heavy materials like bricks, tiles, sand, cement or
- As a mixing table for the mixing of cement, mortar, etc.

Minor swelling that may result due to prolonged exposure to weathering (resulting from the hygro-expansivity of particleboard) can be removed by sanding following the enclosure of the building. The depth of material removed shall not exceed the following:

- 1mm – Over the general panel area
- 2mm – Within 50mm of any supported edge

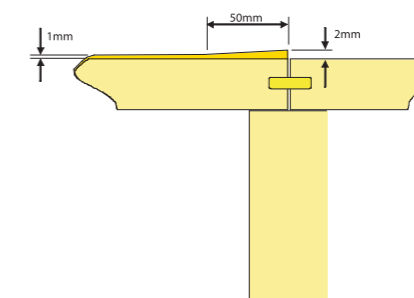

Figure 2. AS 1860.2 Sanding Provision

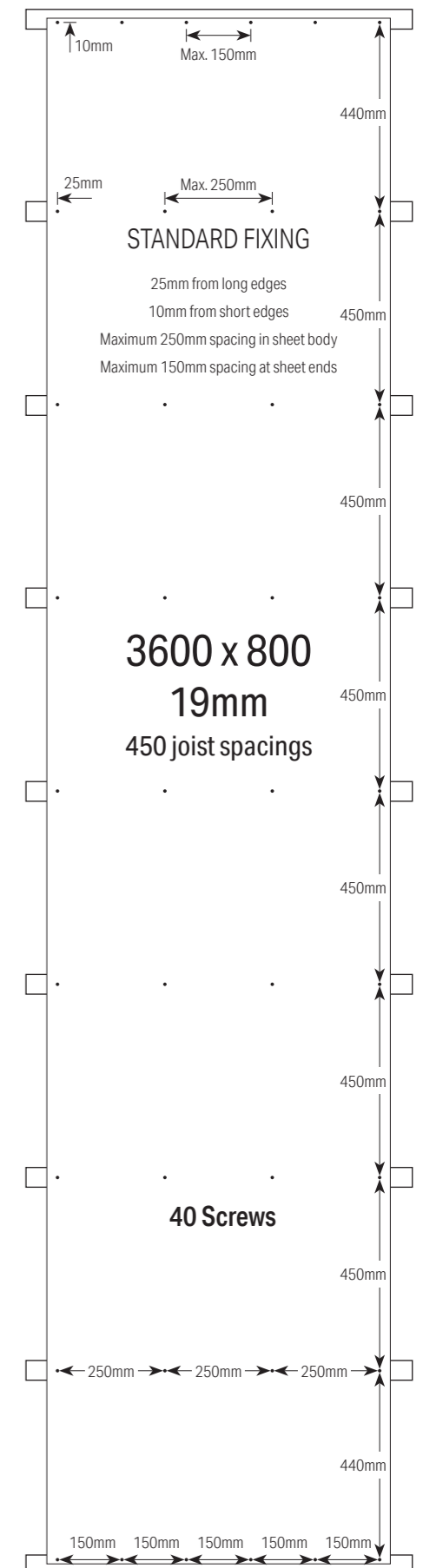

Figure 3. Fixing plan

Double Layers

The additional fixing and support details are required for Concentrated Loads higher than 6kN or Uniformly Distributed Loads higher than 20kPa – refer to section on Load tables. In this case the bottom sheet only requires screw fixing and full support on all edges.

When installing double layers, install the first layer as per the installation requirements on page 11. The second layer is to be laid so that the long joints are staggered between the two layers and the end joints meet on a different floor joist. A bead of adhesive is to be applied on the first layer at the joist position and fasten through both layers into floor joists.

Fastener length for the second layer should provide at least 30mm penetration into joists.

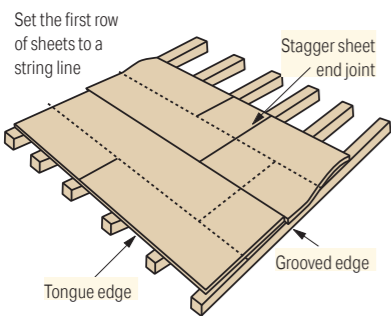
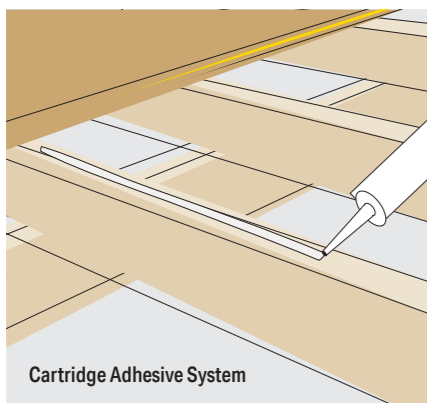

Figure 3. Double Layer Layout



Note:

AS 1860.2 Particleboard Flooring – Installation

1. Advises that adhesive applied along the tongue helps to keep tongues tight in their grooves and minimises squeaking in installed floors.
2. Recommends that panels be factory sealed against water penetration. Where panels are not factory sealed, and where panels are cut to size on site, the edges should be sealed with adhesive used to bond the panels to the joists.
3. The installation of draped Foil type Insulation that provide a disconnect between the joists and flooring is not recommended as it may impede the proper gluing of the flooring to the joists as set out in AS 1860.2 – seek advice and assurance from insulation supplier prior to installation of sub-floor insulation products as to their suitability.

Adhesives

Requirement & Application

Adhesive fixing provides a rigid floor. The use of construction adhesive in conjunction with nails or screws is mandatory.

For cartridge system, cut nozzle to allow a 5mm bead diameter and for foam system regulate flow to achieve the required adhesive bead diameter.

Clean any dirt, grease or water from surfaces to be bonded.

Exude a continuous, 5mm diameter bead of adhesive to each joist to be covered by flooring. Apply two beads to joists where sheets butt together.

An extra bead applied along the tongue before sheets are pressed together will help to achieve a squeak free

floor system. Any excess glue squeezed out should be cleaned off.

Position sheets within approximately ten minutes of applying the adhesive. Do not allow the adhesive to skin over before applying sheets.

Nail or screw flooring sheets within 15 minutes of positioning sheet.

Remove excess adhesive from sheet surface before it dries. Use a scraper and rag dampened with mineral turps (or appropriate solvent).

To seal cut edges of the sheets, apply a bead of adhesive to the edge. Butt the edge firmly up to the adjoining sheet and remove excess adhesive. Alternatively, the adhesive may be spread over the cut edge with a spatula.



STRUCTAflor GP and STRUCTAflor H2

Table 1. Sheet Quantity Estimator*

Width	Thickness x Length	Area	How many sheets do you need?							
			Size of Floor m ²							
			10	25	50	75	100	150	200	250
800mm	19mm x 3600mm	2.88m ²	4	9	18	27	35	53	70	87
600mm	19mm x 3600mm	2.16m ²	5	12	24	35	47	70	93	116

Table 2. Fastener Quantities per Sheet – Standard Fixing

Sheet Size (mm)	Edge Profile	No of Fasteners per sheet	
		Joists at 450mm centres	Joists at 600mm centres
3600 x 600	Tongue and Groove	31	25
3600 x 800	Tongue and Groove	40	32

Table 3. Fasteners

Fastening method	Joist material	Fastener type	Flooring	Minimum fastener
Screw Fixing Preferred Method	All timbers	Type 17 countersunk, self-drilling wood screws	19mm, 22mm	10g x 50mm
Screw Fixing Preferred Method	All timbers	Type 17 countersunk, self-drilling wood screws	25mm	14g x 65mm
Screw Fixing	Steel	Countersunk self-embedding head, self-drilling screws, preferably with self breaking cutter nibs	19mm, 22mm, 25mm	9g x 45mm or 10g x 45mm
Manual Nailing	Hardwood or Cypress Pine	Bullet head or flathead nails	19mm, 22mm	50mm x 2.8mm
Manual Nailing	Hardwood or Cypress Pine	Bullet head or flathead nails	25mm	65mm x 3.75mm
Manual Nailing	Softwood	Bullet head or flathead nails	19mm, 22mm	65mm x 2.8mm
Manual Nailing	Softwood	Bullet head or flathead nails	25mm	75mm x 3.75mm
Machine Driven Nailing	Hardwood or Cypress Pine	D head, round head or finished head	19mm, 22mm	50mm x 2.5mm
Machine Driven Nailing	Hardwood or Cypress Pine	D head, round head or finished head	25mm	65mm x 2.5m*
Machine Driven Nailing	Softwood	D head, round head or finished head	19mm, 22mm	65mm x 2.5m*
Machine Driven Nailing	Softwood	D head, round head or finished head	25mm	75mm x 2.5mm*
Pneumatic Nailing	All timbers	Tee or finishing head nails	19mm, 22mm	50mm x 2.5mm
Pneumatic Nailing	All timbers	Tee or finishing head nails	25mm	75mm x 3.15mm

* Available in D head or round head only.

Note:

1. Use galvanised nails designated for wet areas.
2. Skew bullet or jolt head nails for improved holding.
3. Steel screws should be suitably coated to resist corrosion. To determine if there are alternative methods please contact your Sales Manager.

Fasteners

Select an appropriate fastener from Table 2. The fastener type, length and gauge is based on the particleboard thickness, joist material and available fastening equipment.

Fastener Spacing

For all flooring system's sheet edges, space fasteners at 150mm centres. Keep fasteners at least 10mm from square edges and 25mm from tongue and grooved edges.

In the body of the sheets, space fasteners at 250mm centres for 800mm wide flooring and 300mm centres for 600mm wide flooring. Drive fasteners flush with the STRUCTAflor GP and STRUCTAflor H2 surface. Immediately prior to sanding, punch fasteners 2mm below the surface.

Fixing to Timber I-beam joists

AS1860.2 states that when particleboard flooring is fixed to I-beam joists, screws (not nails) should be used. I-beam flanges may only be 35mm thick and nails will penetrate through and may not have sufficient holding strength.

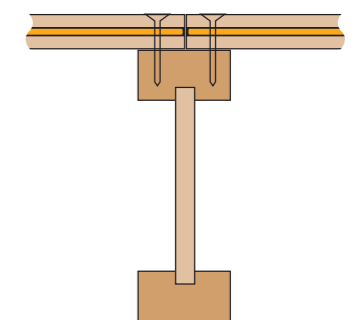

Figure 4. Fixing to EWP I-Beam

R-Values Downwards or Upwards?

Heat always travels from warmer to cooler areas. Insulation works by reducing the amount of heat escaping from your home when it's cold outside and entering your home when it's hot outside. In winter it is usually colder underneath the floor so insulation is needed to stop heat escaping downwards into the subfloor. At hot times of the year, insulation may be needed to stop heat travelling upwards through the floor.

The direction in which insulation needs to inhibit this heat transfer, depends upon if the climate zone your home. R-values can be measured depending on the direction of heat flow (upward or downward) that one wants to reduce. In cooler climates higher down R-values and lower up R-values are appropriate. In hot, humid climates where houses are naturally ventilated, lower down R-values and higher up R-values are appropriate for floors "Guide to building in bushfire affected areas".

Energy Efficiency

Homes with suspended particleboard floors can be designed to meet home energy efficiency and thermal comfort regulations across Australia.

Energy Efficiency Regulations Overview

Across Australia, energy efficiency regulations vary between the different states and territories. Generally speaking there are two ways to meet the regulations, either with an elemental approach or with a modelling approach.

Note that in both approaches the floors on mezzanine, first and higher floors do not have any energy efficiency requirements to meet.

Elemental Approach

The elemental approach sets out, among other things, specific minimum insulation levels for the various elements of a house – walls, ceilings and so on and includes minimum requirements for the ground floor. This approach is called acceptable construction in the Volume 2 of the Building Code of Australia (BCA), deemed-to-satisfy in Volume 1 of the BCA, and Rapid or DIY method under the NSW BASIX system.

For most states and territories all the energy efficiency requirements for the ground floor element are in the

latest edition of the BCA. However some states may have exemptions from or additional requirements to the BCA. Some states may also have requirements which refer to previous editions of the BCA.

Modelling Approach

The modelling approach requires a home to meet minimum energy efficiency levels for the energy needed to heat and cool the whole house. These minimum levels are set by the state and territory governments and are minimum 5 star, 6 star rating and so on or, in the NSW BASIX system, minimum heating and cooling loads which vary depending on the homes location. The minimum energy efficiency of the whole house as designed is required to be modelled using computer software such as FirstRate, AccuRate or BERS Professional by a trained energy assessor. This modelling approach allows considerable flexibility in how a home achieves the minimum energy efficiency rating. It may mean, for example, that no additional insulation is required on the ground floor because of increased wall and ceiling insulation (it is also usually easier and cheaper to install more insulation in these areas) or changes to glazing type, coverage or frames.

An average home using STRUCTAflor GP, STRUCTAflor H2 or R-flor particleboard flooring on the ground floor can generally achieve the required energy efficiency star ratings (or equivalent) for the building fabric by one or more of the following:

- Increasing insulation in the wall, ceiling or internal walls
- Correct building orientation to take advantage of sunlight, shade or breezes
- Providing summer shading and ventilation
- Providing outdoor living areas in warm climates

- Correct glazing sizing, location frame type In cooler or temperate climate zones additional measures may be needed such as:
 - Draught proofing
 - Enclosing the subfloor perimeter with a wall
 - Blocking the wall cavity if building a block or brick veneer home
 - Installing additional insulation under the floor

For both approaches the insulation properties of the particleboard flooring or the insulation properties of particleboard flooring when used as part of a particular floor system will need to be known. Guidance of both is provided below.

Particleboard Flooring R-Values

Insulation value is commonly called an "R-value" and is a measure of thermal transmittance. There are two ways in which R-values are listed:

- Product or material R-value is the R-value of the product or material on its own.
- System R-value includes the combined insulation value of flooring material, air spaces, any additional insulation and other variables working in conjunction.

STRUCTAflor GP, STRUCTAflor H2 and R-flor all have a material R-value. The R-values for suspended particleboard ground flooring vary and R-values for a common selection of systems are included in Table 5.

Specific floor system R-values can vary depending on:

- Sub-floor perimeter enclosure – if the area under the ground floor (the subfloor) is enclosed the air movement is greatly reduced, substantially increasing the R-value of the floor system.

Note that minimum sub-floor ventilation rates, which vary depending on the building location and its humidity zone, must be adhered to.

- Building location and sub-floor ventilation – a building located in a lower relative humidity zone requires less subfloor ventilation if the sub-floor perimeter is enclosed. Less ventilation (and air flow) increases the R-value of the floor system.
- Building exposure – a floor system of a building in a suburban area will have a higher R-value than a floor system installed in an exposed rural or seaside location.
- Sub-floor perimeter material – if a subfloor is enclosed with materials with a higher material R-value then the ground floor system will have a higher R-value.
- Height above ground level – floor systems close to the ground have a greater thermal connection with the earth so will have a higher R-value than one that is further off the ground.
- Wall cavity barrier – if where a sub-floor perimeter is enclosed and brick or block veneer is the method of construction, installing a barrier below floor level to prevent convection between the airspace under the floor and any wall cavities will substantially increase the R-value of a floor system. Note that in warm, humid climates a wall cavity barrier will reduce the ability of the home to cool off so in some climate zones this is not an elemental requirement.
- Floor joist depth – a floor joist of greater depth will slightly increase the R-value of a ground floor system as more insulating air is trapped underneath.

- Soil type – clay soils are less thermally conductive than sandy soils so a suspended ground floor built over clay soil will have a higher R-value.
- Flooring material – a flooring material which conducts less heat (such as particleboard or carpet) will increase the R-value of a floor system.

Additional Insulation

If additional insulation is required for the ground floor it may be added on top of or underneath the floor or even on the inside of the sub-floor perimeter walls. The following options are available:

On Top of the Floor

Carpet and underlay laid on top of the particleboard flooring can add a significant insulation effect. An increase in R-value of approximately R0.5 (downwards and upwards) can be expected.

Carpet and underlay can increase R-value (down and up) by R0.5.

Laying tiles directly onto particleboard flooring will result in only a slight increase in system R-value. The effect on R-values of timber finishes such as floating timber floors or tongue and groove timber varies depending on the type of wood and the substrate materials. Consult with the manufacturer of these products on their specific material R-values.

Be aware that the insulation on top of a floor may not be recognised by some building authorities or energy rating software as additional insulation. Check with your local building authority or energy rating professional about the acceptability of this in your area.

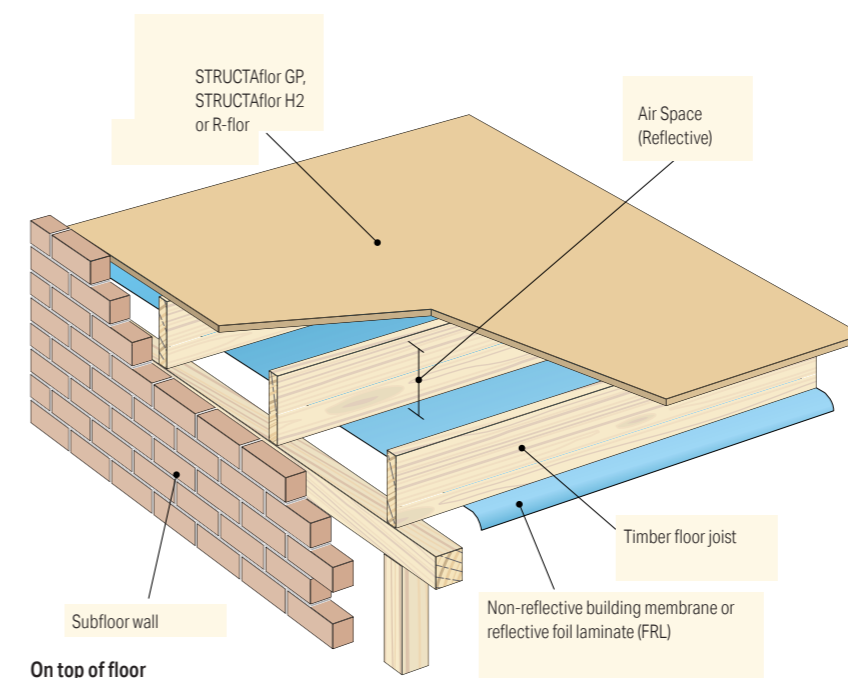
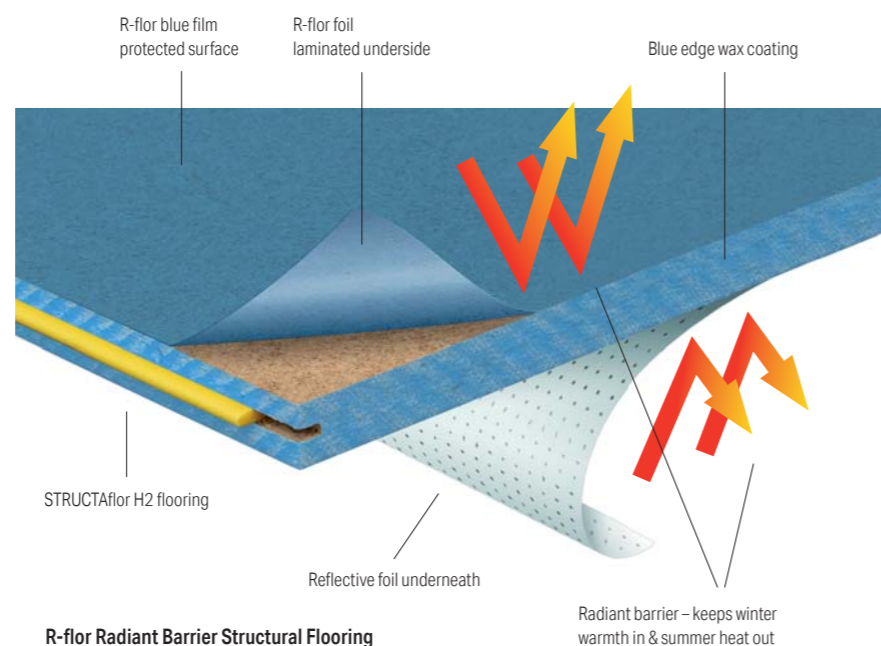

Fixing to Timber & Steel Joists

Adhesive & Fixing Requirements

Good quality flexible adhesive MUST be used.

The correct amount of anti rust screws MUST be used (40);

- **Screws required**
 - **19mm**
450mm joist spacings - 40 screws
 - **22mm / 25mm**
600 joist spacings - 32 screws

- **Fixing onto timber joists**
 - **19mm / 22mm**
10g x 50mm type 17 countersunk, self drilling wood screws.
 - **25mm**
14g x 65mm type 17 countersunk, self drilling wood screws.

- **Fixing onto steel joists**
 - **19mm**
9g x 45mm countersunk self embedding head, self drilling screws.
 - **22mm / 25mm**
10g x 45mm countersunk self embedding head, self drilling screws.

Additional Installation Requirements

Weather proof tape MUST be used over the joists as well as over fixings that have penetrated the plastic cover.

Any damage to the plastic cover MUST be repaired straight away using weatherproof tape.

Flexible adhesive MUST be placed on the joist as well as in the groove that the plastic tongue goes into.

Expansion joints

- 10mm around outside perimeter,
- Tongue and groove side of the board (long joint) can be butted hard together,
- On the end of each sheet as it sits on the joist (short end) leave a 2-3mm gap, this gap can be filled also using the same flexible adhesive you used on the joists,
- Any cut edges or service penetrations should have adhesive applied to them to provide a seal.

Under the Floor

The addition of insulation under the floor can result in either small or large increases in R-value to a ground floor system.

Installing R-flor significantly reduces the radiative heat transfer from the warm living space through the floor into the cool subfloor space to deliver an improvement in the R-value (downwards) of the flooring system. R-flor can add up to R0.6 downwards insulation value to a ground floor system.

STRUCTAflor GP, STRUCTAflor H2 and R-flor can be used in conjunction with other insulation products below the floor.

It is important that the R-flor reflective coating requires an air gap underneath to work effectively. Bulk insulation pressed up against the coating, will negate R-flors additional insulation value.

R-flor has a high reflectance metallised foil coating underneath which significantly reduces radiative heat transfer between the living space and the sub-floor area, substantially increasing R-value (down) of a ground floor system.

Fixing a non-reflective building membrane between or under floor joist is considered to add an R-value of 0.2 (downwards and upwards) in the BCA. Fixing reflective foil laminates (RFLs) between or under floor joists will achieve a higher R-value however, the specific R-value needs to be determined for each product and the airspace above the RFL. Typically a double-sided RFL

attached beneath the floor joists with 90mm airspace can add an R-value of at least 1.97 downwards and 0.55 upwards.

Fixing reflective foil laminate (RFL) underneath floor joists where the sub-floor perimeter is enclosed substantially increasing R-value (down) of a ground floor system.

Placing bulk insulation such as expanded polystyrene or fibre batts will add significant R-value when installed under a floor system. Bulk insulation is available from anywhere between R1.5 to R3 and is usually installed between the floor joists. Depending on the available access bulk insulation can either be placed between the floor joists and held there by friction or placed on top of wire or netting or on stirrups placed over the floor joists.

Use of expanded polystyrene between floor joists can add significant downward R-value to a suspended particleboard floor. Friction fitting or laying on top of floor bearer may be possible with some systems.

When using bulk insulation and recalculating total floor system R-value care must be taken as it is not a straight forward matter of adding the material R-value. The bulk insulation displaces air which itself has some insulation effect.

For example installing fibre batts with an R-value of 1.5 between the floor joists will increase the R-value by R0.74 (upwards) and R1.21 (downwards) not R1.5.

Bulk fibre insulation installed on top of wire netting

between floor joists adds significant downwards R-value. Note the airspace above the insulation which is needed to maximise benefit of reflective foil coating under R-flor.

Inside the Sub-floor Perimeter Wall

In cold climates installing additional insulation inside the sub-floor wall enclosing the perimeter will improve the insulation performance of the floor system. Again, take care that the minimum sub-floor ventilation requirements for the buildings humidity zone are adhered to ensure adequate air movement under the floor.

The installation of a membrane or RFL draped over the floor joists is not recommended as it may impede the proper gluing of the flooring to the floor joists as set out in Australian Standard AS1860.2. This Standard states that the use of construction grade adhesive in conjunction with nails or screws is mandatory. The installation of a draped membrane or RFL may interfere with the function of the adhesive between the flooring and floor joist.

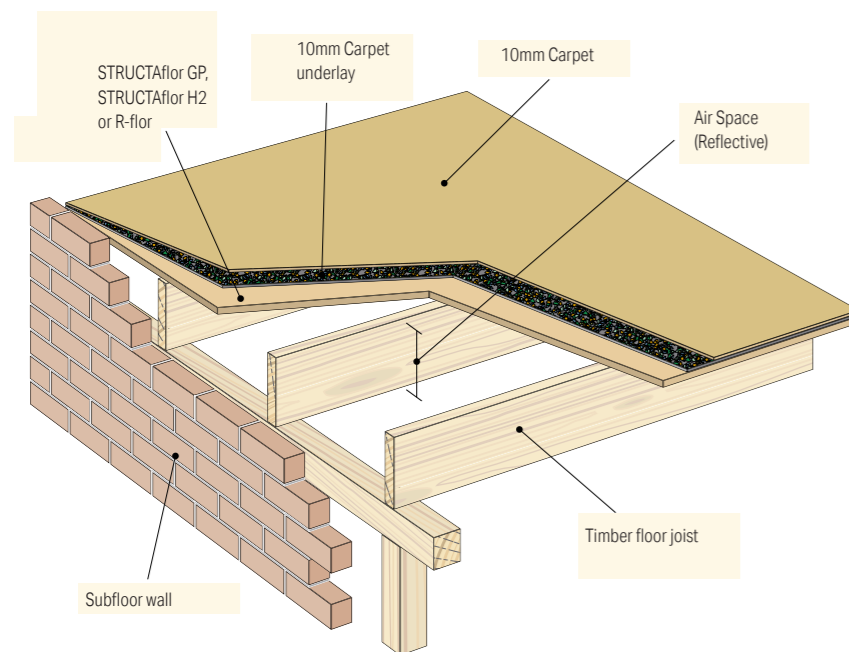

Under the floor

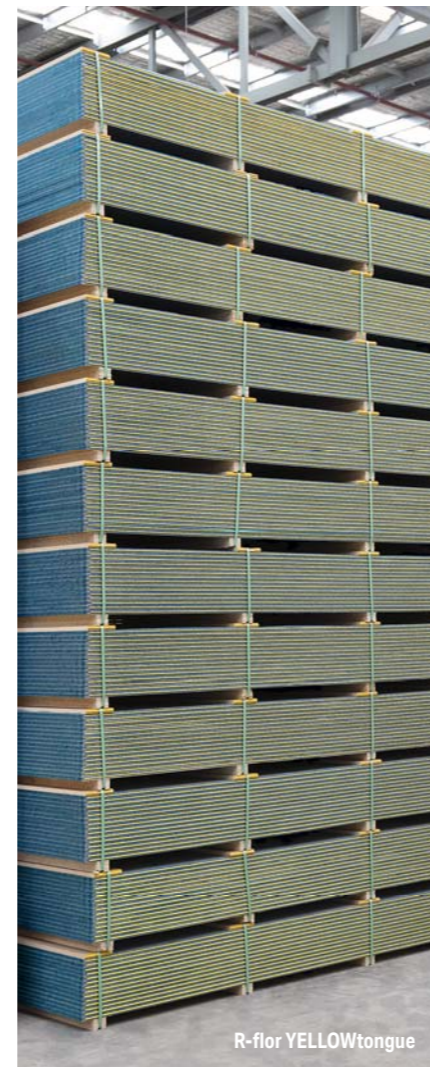

R-flor YELLOWtongue

Further Information

Research funded by the Forest Wood Products Australia (FWPA) has identified a number of options for insulating under floors in the report "Insulation Solutions to Enhance the Thermal Resistance of Suspended Timber Floor Systems in Australia". This report can be found at www.timber.org.au in the Design and Construction section under Thermal Performance.

Due to the magnitude of solutions and products available only a few systems are noted above. Advice on the most suitable product for your climate and conditions including information on correct installation of additional insulation under the floor is to be sought from the insulation supplier/manufacturer.

Hints

Apply a quality duct tape to joins as soon as practical after installation.

- During platform exposure apply appropriate drainage to facilitate evacuation of moisture.

- Do not drill drainage holes in the particleboard flooring in areas that drain into insulation underneath the floor.
- Ensure that the floor and sub-floor space is kept as dry as possible to prevent mould and fungal growth.
- If using draped RFL over the floor joists (not recommended) ensure that the RFL is perforated where the trough is formed with a minimum 6mm diameter holes at spacings of 300mm to allow water to pass through.
- Precautions need to be taken so the insulation does not get wet during construction which may cause mould or fungal growth to develop under the flooring.
- If underfloor insulation does get wet, ensure adequate sub-floor air ventilation and circulation is present to dry it out.
- Care must also be taken not to over insulate the

floor. In hot climates or in other climates at warmer times of the year too much under floor insulation may prevent the building cooling off, resulting in increased use of air-conditioning to ventilate or cool the inside of the home.

- Placing additional insulation underneath floors where the sub-floor perimeter is not enclosed may require additional support to keep insulation in place. Lining underneath the floor joists with particleboard or plywood may be needed to deliver additional R-value required and secure the insulation.

For additional information on R-Values for R-flor REDtongue and R-flor BLUEtongue, kindly visit our website:

www.australianpanelproducts.com.au

Flooring Product Details		STRUCTAflor GP and STRUCTAflor H2 YELLOWtongue (19mm)		R-flor YELLOWtongue (19mm)	
Height of floor above the ground (metres)		0.6	1.2	0.6	1.2
Additional Insulation Type	Direction of Heat Flow	R-Value			
No additional insulation	Downwards	1.06	0.91	1.67	1.52
	Upwards	0.93	0.79	1.06	0.91
With carpet and underlay	Downwards	1.54	1.39	2.15	1.99
	Upwards	1.42	1.27	1.54	1.39
No carpet and nonreflective membrane between or under joists	Downwards	1.26	1.11	1.87	1.72
	Upwards	1.13	0.99	1.26	1.11
No carpet and RFL under joists	Downwards	2.95	2.80	3.42	3.27
	Upwards	1.52	1.38	1.61	1.46
No carpet & R1.5 bulk insulation between joists*	Downwards	2.54	2.39	2.94	2.81
	Upwards	2.40	2.25	2.79	2.65

Table 1. R-values for selected suspended ground floor systems using STRUCTAflor GP, STRUCTAflor H2 and R-flor YELLOWtongue – enclosed perimeters

Note:

1. R-values for typical suburban location in humidity zone 3, standard brick veneer with a wall cavity barrier, sub-floor enclosed with single skin masonry (110mm), floor joist depth 90mm over a clay soil.
2. Bulk insulation is assumed to sit flush with the bottom of the floor joist, leaving an airgap between the top of the bulk insulation and the bottom of the particleboard flooring.
3. R-values calculated in accordance with the relevant provisions of Australian Standard AS/NZ4859.1 – Materials for the thermal insulation of buildings. General criteria and technical provisions and the International Standards Organisation standard ISO 13370 – Thermal performance of buildings – Heat transfer via the ground – Calculation methods is used as the methodology for determining the R-value of suspended timber floors.
4. Assumption of carpet: 10mm carpet, 10mm underlay both with conductivity of 0.05 W/m²K.
5. Additional R-value for adding a non-reflective membrane between or under joists is considered to add an R-value of 0.2 to the total R-value of the base floor construction as advised in BCA 2010 Volume Two.

* 90mm joists, fibreglass insulation

Australian Panels recommend the use of a Fibre Cement Underlay in all ceramic tile applications.

Particleboard flooring provides an economical flooring option for the application of impervious waterproofing systems in wet areas such as bathrooms, laundries and toilets. The waterproofing of floors and floor/wall joints in these areas is essential to prevent water damage to the substructure

and adjoining rooms or spaces.

Waterproofing systems for wet area floors must comply with regulatory requirements. Systems which comply with AS 3740, have a State or National Certificate of Accreditation are generally suitable for use over particleboard flooring.

Australian Standard AS 3740, defines "waterproof" and "water resistant" and specifies which treatment is required for wall and floor areas in bathrooms, toilets and laundries under various arrangements. When treated in accordance with AS 3740, with sealants and membranes meeting AS 4858, particleboard flooring Wet Area Membranes are

suitable for use in all wet areas.

Before installing waterproofing systems or shower bases/trays, seal all cut edges of the product, including holes for service pipes, with epoxy resin. Construction grade adhesive may also be used.

Note:

Movement of the subfloor members due to shrinkage, attention to fixing detail or from subsequent floor loads can be detrimental to the performance of floor surfacings, e.g.: waterproofing systems and ceramic tiles. Close attention should be given to the fixing detail in the design and construction of the floor.

Wet Area Surfacing

In shower areas, ceramic tiles are usually laid in a mortar bed applied over the shower tray. Where the ceramic tile application extends over the wet area room, the product should be waterproofed with an insitu sheet membrane or proprietary liquid membrane as in the shower area.

Alternatively, the floor surface outside the shower area should be sealed with an epoxy sealer. Apply a second coat of sealer and place the mortar, usually 3 parts sand to 1 part cement, while the epoxy sealer remains tacky.

In accordance with Australian Standard AS 3958.1, Guide to the Installation of Ceramic Tiles, mortar beds should be reinforced with galvanised 50mm x 50mm welded wire mesh, 2.5mm diameter. A minimum mortar bed thickness of 40mm is recommended.

Some floor surfaces which are outside the shower area may not be required to slope to a floor waste outlet. Please check with your local building authority.

Where 6mm fibre cement is applied over the product as a base for ceramic tiles or resilient sheet or tile floor coverings, fix sheet strictly in accordance with the manufacturer's instructions.

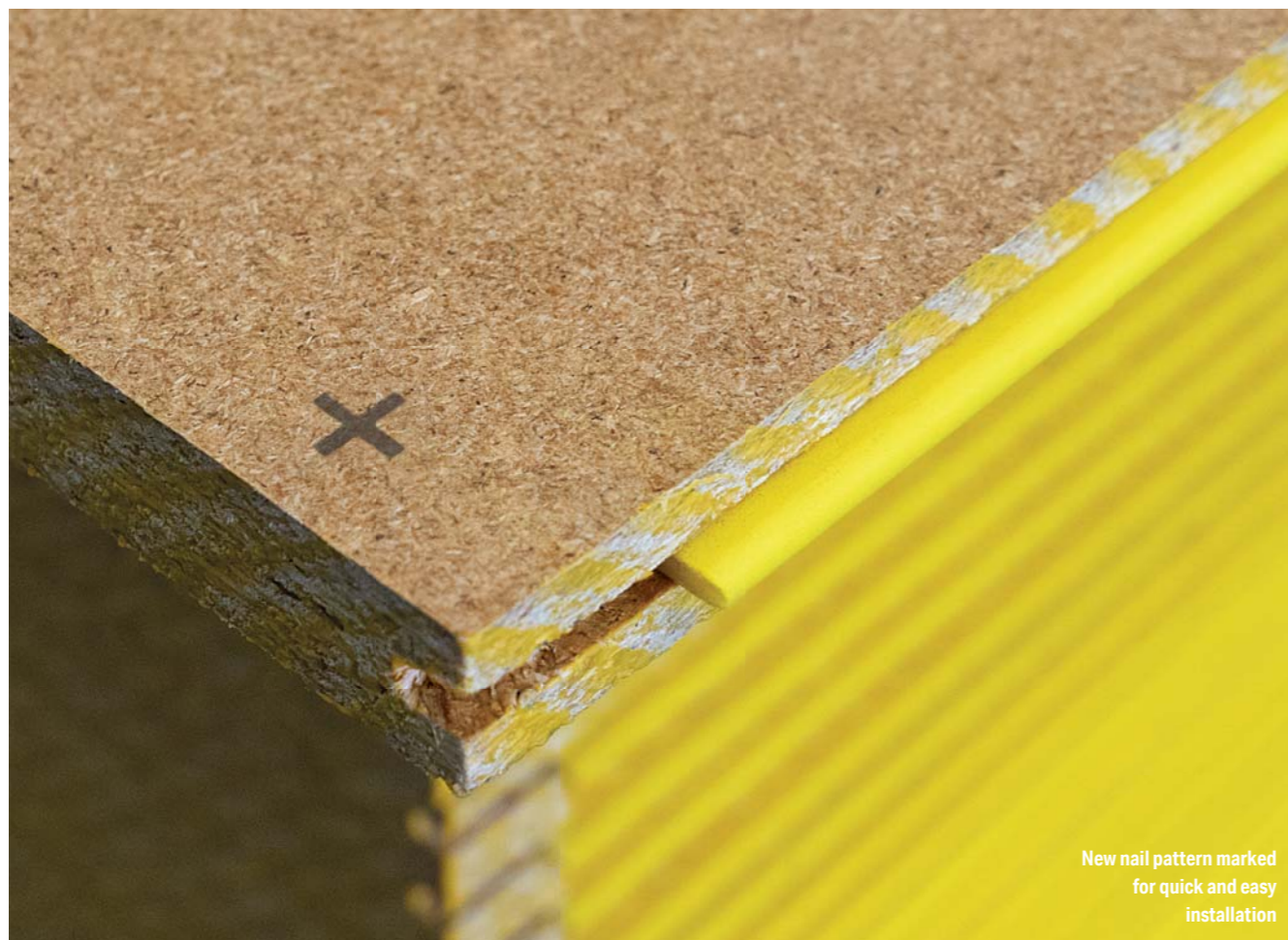

New nail pattern marked for quick and easy installation

Particleboard flooring is an ideal base for underlayments, floor coverings and finishes. Surface treatments include carpet, vinyl sheet or tile, cork, linoleum, quarry or ceramic tile and clear or tinted paint coatings.

Surface Finishing

Apply the covering or finish in accordance with the manufacturer's instructions. The installation should also meet the requirements of the relevant Australian Standards:

AS/NZS 2455.1, Textile Floor Coverings – Installation practice general.

AS/NZS 2311, Guide to The Painting of Buildings.

AS 3958.1, Ceramic Tiles – Guide to the Installation of Ceramic Tiles.

AS 3958.2, Ceramic Tiles – Guide to the Selection of a Ceramic Tiling System.

Preparation

Preparation of particleboard flooring to receive floor surfacings will depend on the type of covering or finish and the effect of weather exposure on the floor.

Preparatory work should be undertaken only when the building is closed and weather tight. STRUCTAflor which has been wetted must be allowed to dry to a moisture content below 10%.

Check that the STRUCTAflor is fixed tightly to joists, as per "Installation Details" page 7.

Drive fasteners below the floor surface to facilitate sanding and minimise "nail popping" in the event of substructure shrinkage.

Sanding

Sand the surface of the product to level sheet joints and fixing points, even out irregularities and remove any loose weathered particles. For general purpose sanding use 40-60 grit closed coat paper. Refer to sanding provisions detailed under Platform Exposure above.

Heavier sanding, with maximum 40 grit paper, may be required on floors which have been exposed to severe wetting. Avoid excessive sanding and limit to a 1mm maximum cut over general floor areas, 2mm maximum cut over supported sheet joints, in accordance with AS 1860.2.

For clear and tinted paint finishing, the product should be fine sanded with 100 grit closed coat paper.

After sanding, remove all dust, preferably by vacuum cleaning. The prepared surface should be dry, clean and free of any surface contamination, e.g.: paint, oil, etc.

Quarry & Ceramic Tiles

Australian Panels recommend the use of a fibre cement underlay in all ceramic tile applications.

Resilient Sheet & Tile

Resilient sheet and tile floor coverings, including flexible and semi-rigid PVC, cork, rubber, linoleum and cushioned vinyl require a hard underlay, e.g.: Hardboard Underlay, to meet Australian Standard and floor covering manufacturer's installation requirements.

Note:

STRUCTAflor sheets may vary in colour and appearance. The variation will show through clear and tinted finishes.

Vapour Barriers

An impervious moisture barrier, e.g.: 0.2mm polyethylene, should be laid over any concrete surfaces subject to dampness. Lap and tape all joints and fold the barrier up walls. Loose lay the STRUCTAflor as outlined under "Fixing".

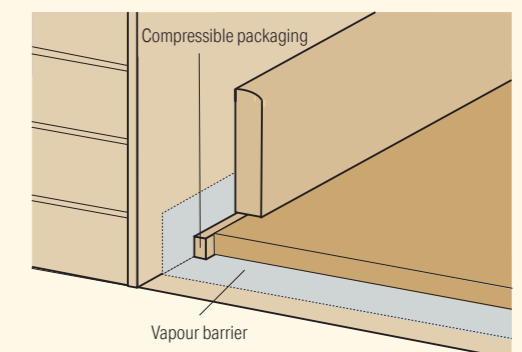

Alternative Applications

Particleboard flooring is suitable for alternative flooring applications to restore old floors, upgrade concrete floors, reduce sound transmission or accommodate subfloor services for computers, telephones, plumbing, etc.

Raft & Floating Floors

To reduce sound transmission through existing floors, particleboard flooring may be used as a raft or floating floor over a layer of resilient material, e.g.: Caneite insulating board, expanded polystyrene, resin bonded fibreglass, etc. The purpose of the assembly is to isolate the existing floor and walls from surface vibrations associated with airborne sound and impact e.g.: footsteps.

Raft or floating floors are not fixed to the subfloor. They are held in position by their own weight and by skirting fixed to perimeter walls.

Best results are obtained where the floor systems are applied over concrete to reduce impact noise transmission to the room below. Another recognised control against impact noise is to cushion the impact with a soft floor surfacing e.g.: carpet over felt or other resilient underlay.

Raft or floating floors may also be applied over existing timber floors.

The effectiveness of raft and floating floor systems is limited by their retention of resilience under load. Also by the extent to which pipes, services, etc. form bridges to conduct vibrations between the floor and the structure.

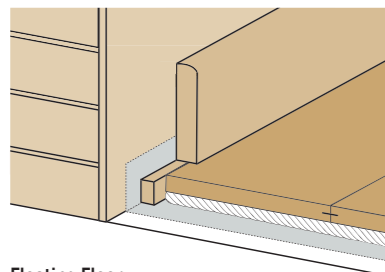

Floating Floor

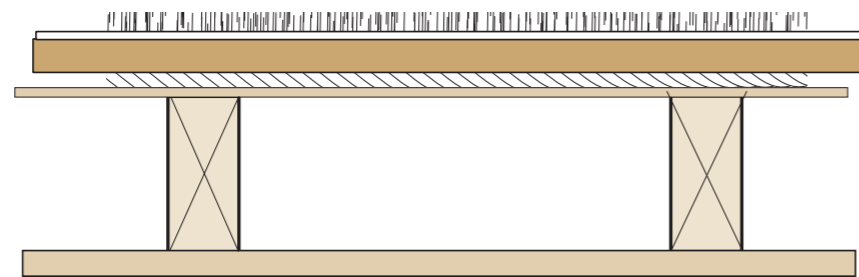

Floating Floor (over timber)



STRUCTAflor installation using screw fixing method

Health & Safety

The normal health and safety precautions should be taken when working with wood panel products. Machine tools should be fitted with dust extractors and work areas kept clean. If dust levels exceed Worksafe Australia standards the wearing of a dust mask (AS/NZS 1715 and AS/NZS 171) and safety glasses (AS/NZS 1337) is recommended.

Storage and work areas should be adequately ventilated.

Product Material and Properties

Table 1 describes typical dimensions and package size available in the STRUCTAflor range.

Table 1. Dimensions and Packaging

Thickness	Edge Type	Length +/- 2mm	Width +/- 2mm	Sheets per pack	Contents (m ²)	Approx Mass per pack (kg)
19mm	YELLOWtongue	3600	800	30	97.2	1116
		3600	600	30	64.8	837
22mm	REDtongue	3600	800	30	97.2	1292
		3600	600	30	64.8	969
25mm	BLUETongue	3600	600	25	54.0	918

Particleboard Flooring Properties

Table 8 contains typical properties for Australian produced particleboard flooring in internal application where they are not subject to prolong wetting or high level of relative humidity. The equilibrium moisture content of the board should be maintained below 13%.

Table 2. Typical Property Values for Class 1 Particleboard Flooring

Source: Facts About Particleboard and MDF EWPA 2010 – www.evp.asn.au

Property	Units	Thickness		
		YELLOWtongue 19mm	REDtongue 22mm	BLUETongue 25mm
Density	kg/m ³	680	680	680
Blending Strength (MOR)	MPa	24	21	24
Bending Stiffness (MOE)	MPa	3500	3250	3750
Internal Bond Strength	MPa	0.70	0.75	0.80
Surface Water Absorption	g/m ²	50	50	50
Thickness Swell (24 hr)	%	3	3	2
Glue Bond Durability	MPa	5.5	5.5	6
Glue Bond Quality	MPa	12	12	12
Thickness Stability	%	11	11	11
Formaldehyde Potential (Desiccator Method)	mg/L	1.3	1.3	1.3

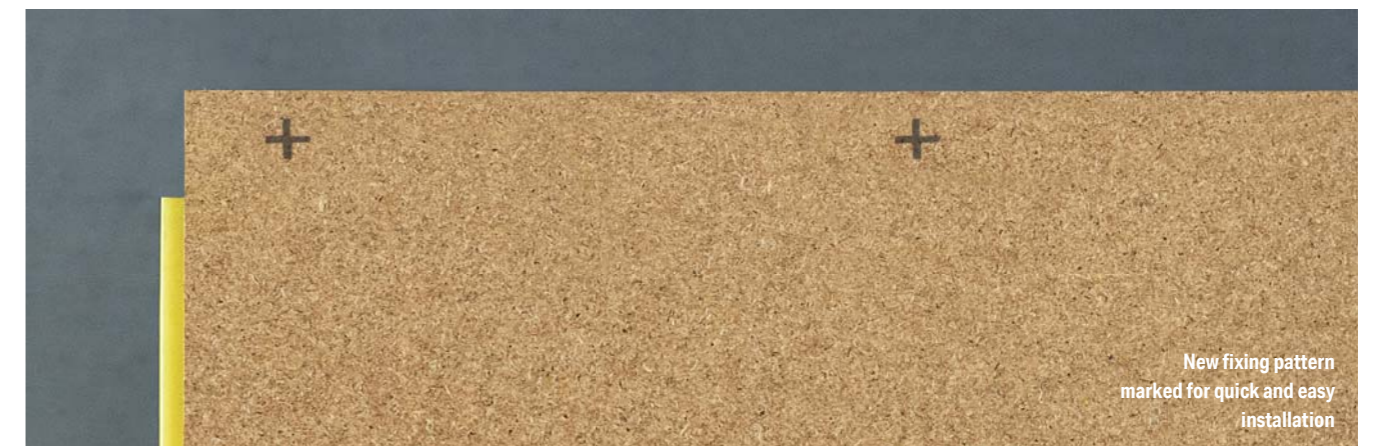

New fixing pattern marked for quick and easy installation

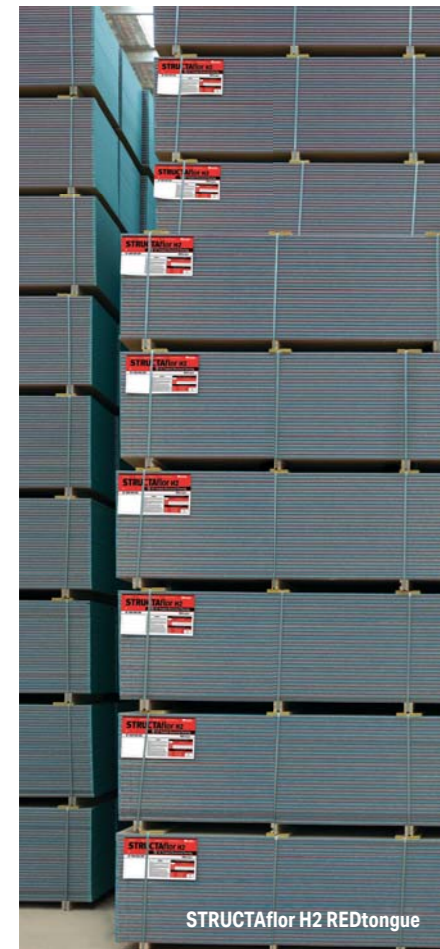

STRUCTAflor H2 REDtongue



STRUCTAflor GP YELLOWtongue

Fire Hazard Properties

For certain building types and locations within the building, the Building Code of Australia stipulates minimum fire properties of materials used in construction. These fire hazard properties are generally used for commercial buildings and are not required for single family houses (Class 1).

Commercial Building

Particleboard used as a flooring substrate – BCA Specification C1.10 – Early Fire Hazard Properties (AS/NZS 1530.3-1999).

This fire hazard property is used where particleboard is not the final floor covering such as under a carpet or tiled floor. In this case the Early Fire Hazard properties are required for most single family homes.

Table 3. Properties of typical particleboard flooring

Source: AWTA (May 2019) test reports 19-002324/5/6

	YELLOWtongue 19mm		REDtongue 22mm		BLUEtongue 25mm	
	Index	Range	Index	Range	Index	Range
Ignitability	13	0-20	13	0-20	13	0-20
Spread of flame	4	0-10	4	0-10	4	0-10
Heat Involved	4	0-10	4	0-10	4	0-10
Smoke Developed	3	0-10	2	0-10	4	0-10

Particleboard used as a Floor Covering – BCA Specification C1.10a (AS/ISO 9239.1-2003)

Where particleboard is used as the actual floor covering (exposed) in commercial buildings, Specification C1.10a of the BCA fire hazard properties places limits on the floor covering performance in various locations within a building or whether sprinklers are used.

Table 4. Test results for typical STRUCTAflor

Source: AWTA (June 2019) test reports 19-001482/5/6

	YELLOWtongue 19mm	REDtongue 22mm	BLUEtongue 25mm
Average Critical Radiant Flux	6.0kW/m ²	4.7kW/m ²	5.9kW/m ²
Average Smoke Obscuration (Smoke Development Rate)	17% min	19% min	28% min

Thermal Insulation

The thermal conductivity of STRUCTAflor GP and STRUCTAflor H2 is 0.12 W/mK. Thermal resistance (R-values) calculated in accordance with the relevant provisions of Australian Standard AS/NZ4859.1 for the nominated thicknesses are:

Table 5.

Product	R-value (Thermal resistance m ² K/W)		
	YELLOWtongue 19mm	REDtongue 22mm	BLUEtongue 25mm
Flooring	R0.16	R0.18	R0.21

Fixing

Can nails be used to fix to steel joists?

No, this is not recommended and is not allowed for in the Australian Standards.

Can nails be used for fixing to I joists?

The Australian Standard recommends screw fixing to I joists. Typically, the I joist flange is 35mm thick, which will result in the nail penetrating through the flange and reducing the holding capacity of the nail.

How do you minimize the risk of a squeaky floor?

For best results it is recommended to use screws and adhesive to fix your floor.

Do I need to use adhesive to fix STRUCTAflor along with screws/nails?

Yes, as per the Australian Standard, the use of adhesive is mandatory when fixing particleboard flooring.

If it is going to rain during installation, should I cover STRUCTAflor with plastic or similar?

No, covering the surface during installation will trap the moisture, this can then lead to mold and other moisture related issues.

After Fixing

Why has my STRUCTAflor swelled at the edges?

This swelling can happen when exposed to weather during construction, as Structaflor is made from natural materials this moisture can result in minor swelling, generally at the edges. This can be corrected by sanding and can be done within the specified tolerance once the floor has dried. The floor will remain fit for its intended purpose with no long term performance issues.

Why have gaps have appeared between sheets?

Generally caused by sheets being wet prior to installation or extreme drying post installation, this generally won't result in a structural issue. The gaps can be filled with an elastomeric filler; however you should wait until the roof is on or the floor is protected from the weather.

Can STRUCTAflor expand and contract with changes to moisture conditions?

Yes, like all timber products, STRUCTAflor can expand or contract as the moisture content of the panel changes. The normal moisture content of STRUCTAflor should be between 8 – 14%. Shrinkage can cause gaps between sheets, this can be

minimised by ensuring STRUCTAflor is stored under cover and kept dry prior to installing. Expansion can be an issue on large floors that are exposed to heavy or continuous wetting. Drilling holes up to 8mm in diameter will minimize pooling on the surface of the floor. The Australian Standard also states that for large continuous flooring widths expansion gaps of 10mm should be positioned every 6m; either a single 10mm gap under a wall or smaller gaps where sheets join adding to 10mm.

Areas of Use

Can I fix ceramic tiles directly to STRUCTAflor?

No, Australian Panels recommends the use of fibre cement underlay between tiles and the STRUCTAflor.

Can STRUCTAflor be used on covered balconies?

No, the structural integrity of the product could be compromised by regular wetting over the extended life of the balcony.

Can STRUCTAflor be used in wet areas ie. bathrooms, laundries and toilets?

Yes, provided the floors and wall to floor joints are fully sealed with a waterproof membrane.



STRUCTAflor GP and STRUCTAflor H2